

# Use and Care & Installation Guide

## 30" Vented Range Hood

Model: JV376



### IMPORTANT SAFETY INSTRUCTIONS

Read and save these instructions.

**WARNING—TO REDUCE THE RISK OF FIRE, ELECTRIC SHOCK, OR INJURY TO PERSONS, OBSERVE THE FOLLOWING:**

- A. Use this unit only in the manner intended by the manufacturer. If you have questions, contact the manufacturer at the address or telephone number listed in the warranty.
- B. Before servicing or cleaning unit, switch power off at service panel and lock service to prevent power from being switched on accidentally. When the service disconnecting means cannot be locked, securely fasten a prominent warning device, such as a tag, to the service panel.
- C. Installation work and electrical wiring must be done by qualified person(s) in accordance with all applicable codes and standards, including fire-rated construction.
- D. Sufficient air is needed for proper combustion and exhausting of gases through the flue (chimney) of fuel-burning equipment to prevent backdrafting. Follow the heating equipment manufacturer's guidelines and safety standards such as those published by the National Fire Protection Association (NFPA), and the American Society for Heating, Refrigeration and Air Conditioning Engineers (ASHRAE), and the local code authorities.
- E. When cutting or drilling into wall or ceiling, do not damage electrical wiring and other hidden utilities.
- F. Ducted fans must always be vented to the outdoors.
- G. To reduce the risk of fire, use only metal ductwork.
- H. This unit must be grounded.

**WARNING—TO REDUCE THE RISK OF A RANGE TOP GREASE FIRE:**

- A. Keep fan, filters and grease-laden surfaces clean.
- B. Always turn hood ON when cooking at high heat.
- C. Don't leave range unattended when cooking.
- D. Use high settings on range only when necessary. Heat oil slowly on low to medium setting.

E. Always use cookware and utensils appropriate for the type and amount of food being prepared.

- When flaming foods under the hood, turn the fan on.

**WARNING—TO REDUCE THE RISK OF INJURY TO PERSONS IN THE EVENT OF A RANGE TOP GREASE FIRE, OBSERVE THE FOLLOWING:**

- A. **SMOTHER FLAMES** with a close-fitting lid, cookie sheet, or metal tray, then turn off the burner. **BE CAREFUL TO PREVENT BURNS.** If the flames do not go out immediately, **EVACUATE AND CALL THE FIRE DEPARTMENT.**
- B. **NEVER PICK UP A FLAMING PAN**—You may be burned.
- C. **DO NOT USE WATER**, including wet dishcloths or towels—a violent steam explosion will result.
- D. Use an extinguisher **ONLY** if:
  1. You know you have a Class ABC extinguisher, and you already know how to operate it.
  2. The fire is small and contained in the area where it started.
  3. The fire department is being called.
  4. You can fight the fire with your back to an exit.

\*Based on "Kitchen Firesafety Tips" published by NFPA.

**CAUTION**—For general ventilating use only. Do not use to exhaust hazardous or explosive materials and vapors.

**If You Need Service...**

- Do not attempt to repair or replace any part of your hood unless it is specifically recommended in this guide. All other servicing should be referred to a qualified technician.

## SAVE THESE INSTRUCTIONS

### Write Down the Model and Serial Numbers.

The Model and Serial Numbers are on a label on the back wall of the hood and on the Consumer Product Ownership Registration Card that came with your hood. Before sending in this card, please write these numbers here:

Model Number

Serial Number

**WARNING: Disconnect power before servicing or cleaning the unit.**

## Blower Control

The speed control can be adjusted from OFF to high speed. At the highest setting, the blower exhausts 410 CFM. It takes about 15 seconds for the blower to reach high speed.. For most effective removal of smoke and odors, turn the fan on at the beginning of cooking and allow it to run until smoke and odors are removed from the room.

## Lights

This hood has two lights. Do not use bulbs larger than 75 watts. There are two light levels. To change light bulbs, first remove the filters. It is not necessary to remove the blower cover.

## Care of Filter

For greatest efficiency the aluminum filter should be cleaned periodically. To remove the filter, pull the tab to the side and then down. Soak it in hot water and detergent. Rinse and dry thoroughly before replacing.

## Care of Exterior Surfaces

Use a mild detergent to clean the hood. **DO NOT** use abrasive cleansers.

## Motor

When the control is not set on high and if the motor seems to be operating at high speed or if ventilation seems inadequate, check the following:

1. Knockouts not removed from hood.
2. Blower installed for vertical discharge instead of horizontal discharge or vice versa.
3. Damper blade not opening.
4. Reduced airflow because the duct is too small or the length is too long.
5. The duct is blocked.
6. Undersized or restrictive wall or roof cap.



# INSTALLATION INSTRUCTIONS

**IMPORTANT: OBSERVE ALL GOVERNING CODES AND ORDINANCES. SAVE THESE INSTRUCTIONS FOR THE LOCAL ELECTRICAL INSPECTOR'S USE.**

## Cabinet Height

For most efficient operation, the top of the hood should be approximately 66" (167.6 cm) from the floor.

## Tools Required:

- Drill; 1/4" wood bit.
- Pliers.
- Flat blade screwdriver.
- Pencil, ruler and level.
- Saber saw or keyhole saw.
- Caulking, metal snips, duct tape, ducts (with elbow and transition, if necessary) and wall cap or roof caps, as required.

## Venting

This hood must be vented vertically through upper cabinets or horizontally through an outside wall. Ductwork is not included.

Improper duct sizing or restrictive roof caps reduce air moving capacity and will not provide enough ventilation for an indoor electric grill.

Indoor electric grills produce more smoke than normal cooking and require at least 410 CFM to provide adequate ventilation.

Follow the guidelines for proper duct sizing in the ducting charts. **NOTE:** The venting system must exhaust to the outside.

## Installing the Range Hood

Determine which direction the vent will be installed (top or rear).

1. Remove filters and motor/light cover (3 screws).
2. Remove the blower motor by removing the "packing screw" and the clip on the retainer bar. Discard the clip and screw.

Unplug the motor from the junction box.

Snap the blower retainer bar toward the rear of the hood to release the blower. Remove the blower.

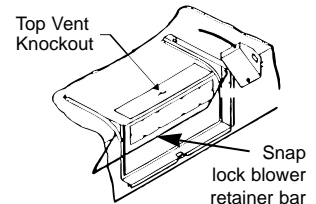

3. Remove the junction box cover.

Remove the selected wiring knockout and duct knockout from the top or rear of the hood. Use a flat blade screwdriver to cut the tabs.

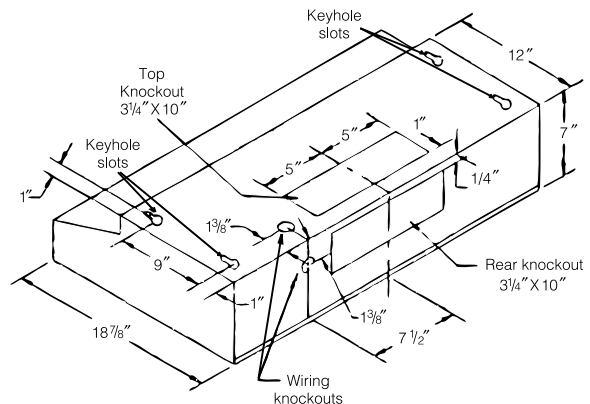



4. Use the hood as a template. Mark the locations on the cabinet or wall for ductwork, electrical wiring and keyhole screw slots. Cut holes at marked locations for duct and electrical wiring. For the vertical duct, cut out 3/4" extra toward the front of the cabinet for movement of the duct when installing the hood.

5. Run the electrical wires through the wall or cabinet according to National Electrical Code and applicable local codes.

**NOTE:** DO NOT turn the power on until installation is complete.

6. Drive the screw partway into the center of the narrow neck of the keyhole slots marked on the cabinets.

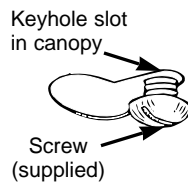

7. Follow the directions for vertical or horizontal venting.

**NOTE:** If the venting installation is NOT correct, the blower will run at maximum RPM regardless of the speed control setting.

**When installing the blower housing, be sure wires cannot contact the blower wheel.**

### VERTICAL VENTING

(If the roof cap has a damper, do not install the damper blade on the hood.)

Attach the damper with the small sheet metal screws (#8 x 1/4").

Check the damper for free operation. Open the damper blade to approximately 80 degrees.

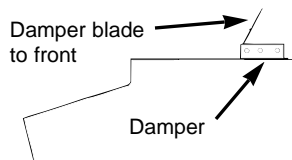

Position the blower for vertical discharge. The air flow arrow on the blower should point up towards the vent opening.

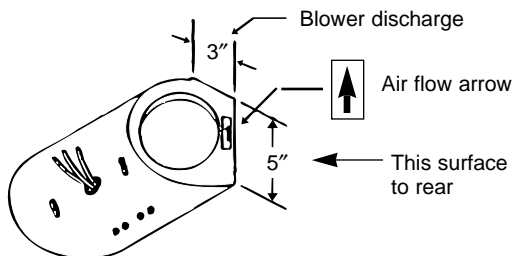

When the blower is in position, snap the blower retainer bar toward the front into the indent. Reattach the plug into the junction box.

### HORIZONTAL VENTING

(If the wall cap has a damper, do not install the damper blade on the hood.)

Attach the damper with the small sheet metal screws (#8 x 1/4").

Check the damper for free operation. Open the damper blade to approximately 80 degrees.

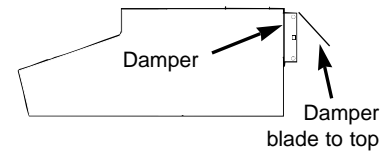

Position the blower for horizontal discharge. The air flow arrow on the blower should point to the rear vent opening.

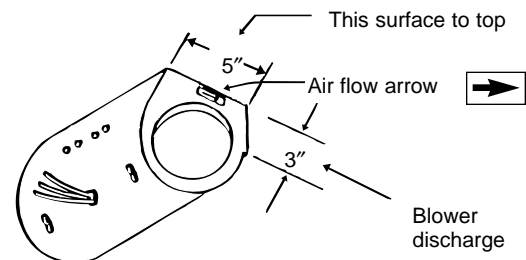

When the blower is in position, snap the blower retainer bar toward the front into the indent. Reattach the plug into the junction box.

8. Lift the hood into position and feed the house wiring through the wiring knockout. Slide the hood back against the wall.

Tighten the mounting screws. Be sure the screw heads are in the narrow neck of the keyhole slot.

9. Complete the electrical wiring in the wiring box according to National Electrical Code and local codes.

**NOTE:** This hood must be permanently grounded.

10. Replace the junction box cover and blower assembly.

Reattach the plug into the junction box.

Install light bulbs (not supplied with the hood).

Reattach bottom motor/light cover and filters.

11. Installation is complete. Turn on the power.



# INSTALLATION INSTRUCTIONS

## Ductwork Requirements

Use 3/4 x 10" or 7" round ducting for best performance. The length of ductwork and number of elbows should be kept to a minimum for efficient operation.

Use caulking to seal exterior openings around the hood.

### Static Pressure vs Duct Length Equivalent Duct Length (ft.)

Static Pressure	CFM	Rect. 3/4 x 10"	7" dia.	8" dia.	9" dia.
.06		4	10	19	34
.10	410	7	17	31	56
.15	400	11	25	47	83
.20	370	15	33	62	111
.25	345	18	42	78	
90° elbow		5	11	12	14
45° elbow		2 1/2	5 1/2	6	7

maximum recommended length

## Ducting Chart

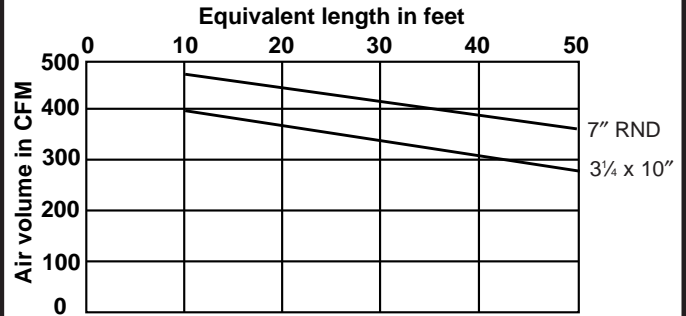

3/4 x 10" Transition to 7" Round = 2 ft.

7" Round elbow = 8 ft.

7" Roof cap = 70 ft.

## YOUR RANGE HOOD WARRANTY

**Staple sales slip or cancelled check here. Proof of original purchase date is needed to obtain service under warranty.**

### WHAT IS COVERED

#### FULL ONE-YEAR WARRANTY

For one year from date of original purchase, we will provide, free of charge, parts and service labor in your home to repair or replace **any part of the hood** that fails because of a manufacturing defect.

This warranty is extended to the original purchaser and any succeeding owner for products purchased for ordinary home use in the 48 mainland states, Hawaii and Washington, D.C. In Alaska the warranty is the same except that it is LIMITED because you must pay to ship the product to the service shop or for the service technician's travel costs to your home.

All warranty service will be provided by our Factory Service Centers or by our authorized Customer Care<sup>®</sup> servicers during normal working hours.

Should your appliance need service, during warranty period or beyond, call 800-GE-CARES (800-432-2737).

### WHAT IS NOT COVERED

- Service trips to your home to teach you how to use the product.

#### Read your Use and Care material.

If you then have any questions about operating the product, please contact your dealer or our Customer Relations office at the address below, or call, toll free:

GE Answer Center<sup>®</sup>  
800.626.2000  
consumer information service

- Improper installation.

If you have an installation problem, contact your dealer or installer. You are responsible for providing adequate electrical, gas, exhausting and other connecting facilities as described in the Installation Instructions provided with the product.

- Replacement of the replaceable filters.

- Replacement of house fuses or resetting of circuit breakers.
- Failure of the product if it is used for other than its intended purpose or used commercially.
- Damage to product caused by accident, fire, floods or acts of God.

**WARRANTOR IS NOT RESPONSIBLE FOR CONSEQUENTIAL DAMAGES.**

Some states do not allow the exclusion or limitation of incidental or consequential damages, so the above limitation or exclusion may not apply to you. This warranty gives you specific legal rights, and you may also have other rights which vary from state to state. To know what your legal rights are in your state, consult your local or state consumer affairs office or your state's Attorney General.

**Warrantor: General Electric Company**

**If further help is needed concerning this warranty, write:  
Manager—Customer Relations, GE Appliances, Louisville, KY 40225**

Part No. 164D2966P166-2

Pub No. 49-8646-2

626778

JV376

Printed in the United States