



INSTALLATION INSTRUCTIONS

**36" Stainless Steel Vent Hood
ZV950**

Safety Information

BEFORE YOU BEGIN

Read these instructions completely and carefully.

- **IMPORTANT** — Save these instructions for local inspector's use.
- **IMPORTANT** — Observe all governing codes and ordinances.
- **Note to Installer** — Be sure to leave these instructions with the Consumer.
- **Note to Consumer** — Keep these instructions with your Owner's Manual for future reference.
- **Skill Level** — Installation of this appliance requires basic mechanical and electrical skills.
- **Completion Time** — 1 to 3 Hours.
- Proper installation is the responsibility of the installer. Product failure due to improper installation is not covered under the warranty.
- For Monogram local service in your area, visit monogram.com.
- For Monogram service in Canada, visit monogram.ca
- For Monogram Parts and Accessories, visit monogram.com/use-and-care/parts.

▲ CAUTION Due to the weight and size of these vent hoods and to reduce the risk of personal injury or damage to the product, **TWO PEOPLE ARE REQUIRED FOR PROPER INSTALLATION.**

▲ ATTENTION À cause du poids et de la taille de ces hottes et pour réduire le risque de blessures et de dommages, **IL FAUT DEUX PERSONNES POUR FAIRE L'INSTALLATION CORRECTEMENT.**

▲ WARNING To reduce the risk of fire or electrical shock, do not use this range hood with any external solid-state speed control device. Any such alteration from original factory wiring could result in damage to the unit and/or create an electrical safety hazard.

▲ AVERTISSEMENT Pour réduire le risque d'incendie ou de choc électrique, il ne faut pas utiliser cette hotte avec un régulateur de vitesse électronique externe. Toute modification de ce type du branchement d'usine peut endommager l'appareil ou créer un risque de choc électrique.

TO REDUCE THE RISK OF FIRE, USE ONLY METAL DUCTWORK.

▲ WARNING TO REDUCE THE RISK OF FIRE, ELECTRICAL SHOCK OR INJURY TO PERSONS, OBSERVE THE FOLLOWING:

- A. Use this unit only in the manner intended by the manufacturer. If you have any questions, contact the manufacturer.
- B. Before servicing or cleaning the unit, switch the power off at the service panel and lock the service disconnecting means to prevent the power from being switched on accidentally. When the service disconnecting means cannot be locked, securely fasten a prominent warning device, such as a tag, to the service panel.

▲ AVERTISSEMENT POUR RÉDUIRE LE RISQUE D'INCENDIE, DE CHOC ÉLECTRIQUE OU DE BLESSURES, IL FAUT OBSERVER LES RÈGLES SUIVANTES :

- A. Utilisez cet appareil uniquement de la manière prévue par le fabricant. En cas de question, consultez le fabricant.
 - B. Avant toute intervention ou nettoyage, coupez l'alimentation électrique au disjoncteur et verrouillez le panneau du disjoncteur pour éviter la mise sous tension accidentelle. S'il n'est pas possible de verrouiller le panneau du disjoncteur, attachez un placard ou une étiquette très visible au panneau.
- For general ventilating use only. Do not use to exhaust hazardous or explosive materials or vapors.
 - Structural framing, installation work and electrical wiring must be done by qualified person(s). In accordance with all applicable codes and standards including fire-rated construction.
 - Sufficient air is needed for proper combustion and exhausting of gases through the flue (chimney) of fuel burning equipment to prevent back-drafting. Follow the heating equipment manufacturer's guidelines and safety standards, such as those published by the National Fire Protection Association (NFPA), the American Society for Heating, Refrigeration and Air Conditioning Engineers (ASHRAE) and the local code authorities. When applicable, install any makeup (replacement) air system in accordance with local building code requirements.
 - Local codes vary. Installation of electrical connections and grounding must comply with applicable codes. In the absence of local codes, the vent should be installed in accordance with National Electrical Code ANSI/NFPA 70-1990 or latest edition.

▲ CAUTION To reduce risk of fire and to properly exhaust air, be sure to duct air outside — do not vent exhaust air into spaces within walls or ceilings or into attics, crawl spaces or garages.

▲ ATTENTION Il faut prendre soin d'installer un conduit vers l'extérieur pour réduire le risque d'incendie et pouvoir évacuer l'air correctement. Il ne faut pas évacuer l'air dans l'espace entre les parois d'un mur, un plafond ou un grenier, un espace sanitaire ou un garage.

READ AND SAVE THESE INSTRUCTIONS

Design Information

CONTENTS

Design Information

Product Dimensions and Clearances	3-4
Optional Accessories	4
Installation Preparation	
Advance Planning, Ductwork, Framing	5
Power Supply	5
Duct Fittings	6
Tools and Materials Required	7
Remove the Packaging	7
Check Installation Hardware	8
Ductwork, Wiring Locations	8

Installation Instructions

Step 1, Install Framing for Hood Support	9
Step 2, Install Mounting Brackets	9
Step 3, Install Duct Bracket	9
Step 4, Install the Hood	10
Step 5, Connect Ductwork	10
Step 6, Connect Electrical	11
Step 7, Install Duct Covers	11
Step 8, Install Filters	11
Step 9, Finalize Installation	11

PRODUCT DIMENSIONS AND CLEARANCES

36" Vent Hood Installation Combinations

This Stainless Steel Hood can be installed over any Monogram cooktop, including the Professional 36" rangetop and 30" or 36" range.

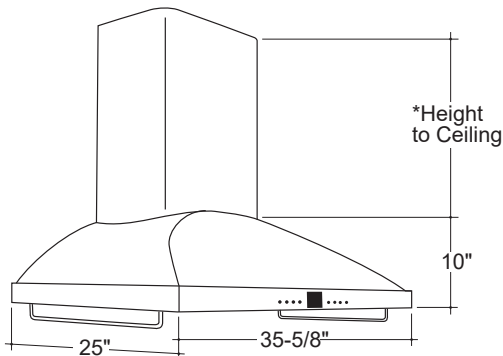

*The supplied duct cover fits 8 ft. to 10 ft. ceilings.

The vent hood must be installed 24" min. and 30" max. above the cooking surface. The hood installation height, from the cooking surface to the bottom of the hood, depends upon ceiling height.

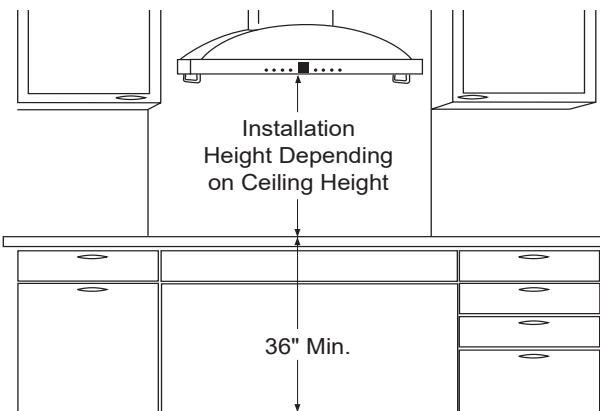

Cooking surface to bottom of hood should be:

- 25-1/2" max. for 8 ft. ceiling height.
- 25-1/2" to 30" for 9 ft. ceiling height.
- 30" min. for 10 ft. ceiling height.

Plan the installation height carefully to avoid unsightly gaps above the hood.

This hood must be installed 30" min. above a Monogram Professional Cooktop or Range. Ceiling height for this installation combination must be at least 8'5" high.

NOTE: The supplied 2-piece duct cover is adjustable to fit 8 ft. to 10 ft. ceilings. For ceiling heights greater than 10 ft. and up to 14 ft., order ZX14SDSS stainless steel duct cover accessory.

ZV950SDSS Duct Cover Dimensions

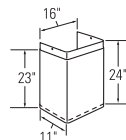

ZX14SDSS Duct Cover Dimensions

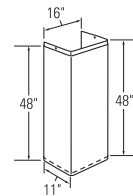

Design Information

PRODUCT DIMENSIONS AND CLEARANCES (Cont.)

Using Duct Cover Accessories

A Duct Cover Accessory may be required for your hood installation height. Use this chart to determine installation height and accessory for your ceiling height.

ZV950SDSS Installation Heights		
Actual Ceiling Height	* Possible Hood Installation Height	Duct Cover
7' 11"	24-1/2"	SUPPLIED
8' 0"	25-1/2"	
8' 1"	25-1/2" to 26-1/2"	
8' 2"	25-1/2" to 27-1/2"	
8' 3"	25-1/2" to 28-1/2"	
8' 4"	25-1/2" to 29-1/2"	
8' 5"	25-1/2" to 30"	
8' 6"	25-1/2" to 30"	
8' 7"	25-1/2" to 30"	
8' 8"	25-1/2" to 30"	
8' 9"	25-1/2" to 30"	
8' 10"	25-1/2" to 30"	
8' 11"	25-1/2" to 30"	
9' 0"	25-1/2" to 30"	
9' 1"	26-1/2" to 30"	
9' 2'	26-1/2" to 30"	
9' 3'	26-1/2" to 30"	
9' 4"	26-1/2" to 30"	
9' 5"	26-1/2" to 30"	
9' 6"	30" min.	
9' 7"	30" min.	
9' 8"	30" min.	
9' 9"	30" min.	
9' 10"	30" min.	
9' 11"	30" min.	
10' 0"	30" min.	ZX14SDSS
14' 0"		

* Based on 36" countertop height.

The serial plate is located behind the removable filters.

OPTIONAL ACCESSORIES

Using Duct Cover Accessories

ZX14SDSS, optional stainless steel duct cover is available for ceiling heights greater than 10 ft. and up to 14 ft.

Order the optional duct cover at the same time as the vent hood and have on site before installation. This kit contains hardware required for installation. This kit contains installation hardware.

NOTE: Duct covers must be installed as shown in this book. Do not "build-in" the duct cover. If service is required, the duct cover must be removed to access hood components.

Installation Preparation

ADVANCE PLANNING

- Determine the exact location of the vent hood.
- Plan the route for venting exhaust to the outdoors.
- Use the shortest and straightest duct route possible. For satisfactory performance, duct run should not exceed 100 ft. equivalent length for any duct configurations.
- Refer to “Duct Fittings” chart on page 5 to compute the maximum permissible length for duct runs to the outdoors.
- When applicable, install any makeup (replacement) air system in accordance with local building code requirements. Visit Monogram.com for available makeup air solutions.

⚠ CAUTION To reduce risk of fire and to properly exhaust air, be sure to duct air outside—do not vent exhaust air into spaces within walls or ceilings or into attics, crawl spaces or garages.

⚠ ATTENTION Il faut prendre soin d'installer un conduit vers l'extérieur pour réduire le risque d'incendie et pouvoir évacuer l'air correctement. Il ne faut pas évacuer l'air dans l'espace entre les parois d'un mur, un plafond ou un grenier, un espace sanitaire ou un garage.

- Use metal ductwork only. These hoods must use 6” round duct. It can transition to 3-1/4” x 12”, reducing the maximum equivalent duct length to 75 feet.
- Install a wall cap with damper or roof cap at the exterior opening. Order the wall or roof cap and any transition needed in advance.

Wall Framing for Adequate Support

- This vent hood is heavy. Adequate structural support must be provided. The hood must be secured to vertical studs in the wall, or to a horizontal support. See page 9.
- We strongly recommend that the vent hood with duct cover be on site before final framing and wall finishing. This will also help to accurately locate the ductwork and electrical service.

POWER SUPPLY

IMPORTANT – (Please read carefully)

⚠ WARNING FOR PERSONAL SAFETY, THIS APPLIANCE MUST BE PROPERLY GROUNDED.

⚠ AVERTISSEMENT POUR DES RAISONS DE SÉCURITÉ, CET APPAREIL DOIT ÊTRE CORRECTEMENT MIS À LA TERRE.

Remove house fuse or open circuit breaker before beginning installation.

Do not use an extension cord or adapter plug with this appliance. Follow National electrical codes or prevailing local codes and ordinances.

Electrical supply

These vent hoods must be supplied with 120V, 60Hz, and connected to an individual, properly grounded branch circuit, and protected by a 15 or 20 amp circuit breaker or time delay fuse.

- Wiring must be 2 wire with ground.
- If the electrical supply does not meet the above requirements, call a licensed electrician before proceeding.

- Route house wiring through conduit as close to the installation location as possible, in the ceiling or back wall.
- Connect the hood wiring to the house wiring in accordance with local codes.

Grounding instructions

The grounding conductor must be connected to a grounded metal, permanent wiring system, or an equipment-grounding terminal or lead on the hood.

⚠ WARNING The improper connection of the equipment-grounding conductor can result in a risk of electric shock. Check with a qualified electrician or service representative if you are in doubt whether the appliance is properly grounded.

⚠ AVERTISSEMENT Le mauvais branchement du fil de mise à la terre peut causer un choc électrique. En cas de doute, consulter un électricien qualifié ou un technicien pour déterminer si l'appareil est à la terre.

Installation Preparation

DUCT FITTINGS

This Hood Must Use an 8" Round Duct. It Can Transition to a 3-1/4" x 12" Duct.

Use this chart to compute maximum permissible lengths for duct runs to outdoors.

NOTE: Do not exceed maximum permissible equivalent lengths!





Maximum duct length: 100 ft. for range hoods.

Flexible ducting:

If flexible metal ducting is used, all the equivalent feet values in the table should be doubled. The flexible metal duct should be straight and smooth and extended as much as possible.

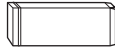
DO NOT use flexible plastic ducting.

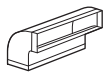
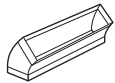
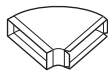
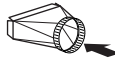
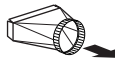
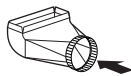
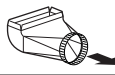
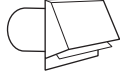
NOTE: Any home ventilation system, such as a ventilation hood, may interrupt the proper flow of combustion air and exhaust required by fireplaces, gas furnaces, gas water heaters and other naturally vented systems. To minimize the chance of interruption of such naturally vented systems, follow the heating equipment manufacturer's guidelines and safety standards such as those published by NFPA and ASHRAE. When applicable, install any makeup (replacement) air system in accordance with local building code requirements. Visit Monogram.com for available makeup air solutions.

Equivalent Duct Piece	Dimensions	Equivalent Length*	Quantity Used	Total Equivalent Length
	Round, straight	1 ft. (per foot length)		
	3-1/4" x 12", straight	1 ft. (per foot length)		
	90° elbow	17 ft.		
	45° elbow	10 ft.		
	3-1/4" x 12" 90° elbow	43 ft.		
	3-1/4" x 12" or 45° elbow	26 ft.		
	3-1/4" x 12" 90° flat elbow	102 ft.		
	8" round to 3-1/4" x 12" transition	2 ft.		
	3-1/4" x 12" to 8" round transition	5 ft.		
	8" round to 3-1/4" x 12" transition 90° elbow	6 ft.		
	3-1/4" x 12" to 8" round transition 90° elbow	13 ft.		
	Round wall cap with damper	32 ft.		
	3-1/4" x 12" wall cap with damper	75 ft.		
	Round roof cap	44 ft.		

*Actual length of straight duct plus duct fitting equivalent. Equivalent length of duct pieces are based on actual tests conducted by GE Appliances Evaluation Engineering and reflect requirements for good venting performance with any ventilation hood.

Total Duct Run _____

Installation Preparation

TOOLS AND MATERIALS REQUIRED (NOT SUPPLIED)

- Tape measure
- Knife
- Spirit level
- Wire cutter/stripper
- Wire nuts
- Electric drill with 1/8" and 3/8" bits
- Phillips and flat blade screwdrivers
- Hammer
- Pliers
- Safety glasses
- Duct tape
- Tape to mount template
- Gloves to protect against sharp edges
- 120V 60Hz. 15 or 20 Amp, 2 wire with ground Properly grounded branch circuit
- Strain relief for junction cover
- 8" round metal duct, length to suit installation

REMOVE THE PACKAGING

The hood is shipped secured to a shipping board with (4) screws. Remove the 4 screws. Two screws are located at the top of the hood. Two are located at the bottom of the hood behind the grease filters.

A shipping bracket, which supports the blower, must also be removed. It is secured with two screws. All screw impressions are Phillips.

- Remove all packaging, the duct covers, and accessories.
- Lift the hood out of the carton.
- Remove and properly discard all plastic wrapping..

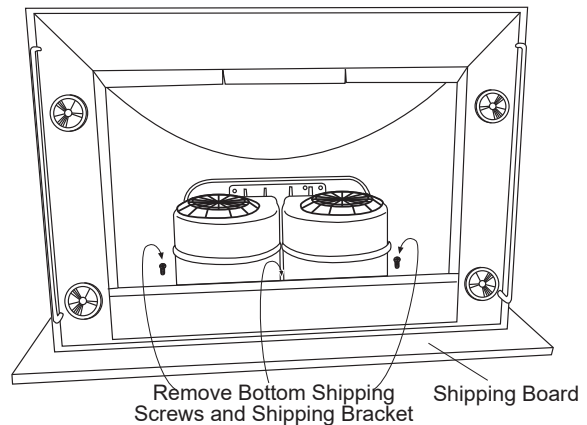

Top Of Hood

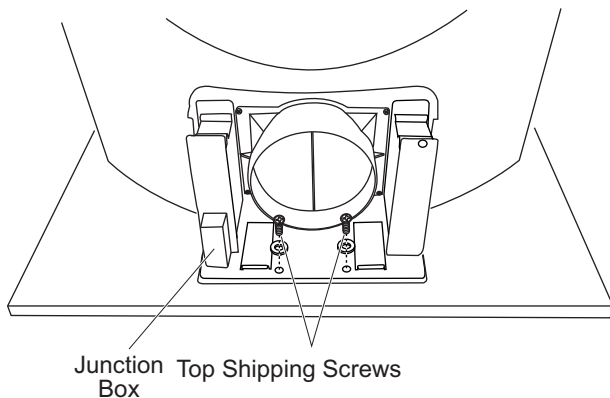

- Remove junction box cover.
- Install strain relief into junction box cover.

Installation Preparation

CHECK INSTALLATION HARDWARE

Locate the hardware accessory box packed with the hood and check contents.

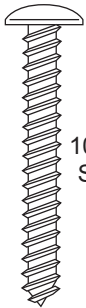

10 Wood Screws



6 Wall Fasteners



2 Large Flat Washers

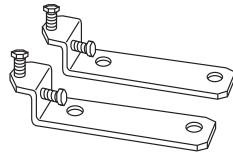

2 Mounting Brackets with 4 Hex Head Leveling Screws

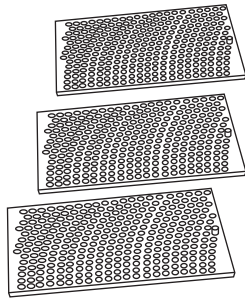

3 Stainless Steel Grease Filters

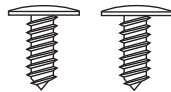

2 Phillips Head Decorative Screws

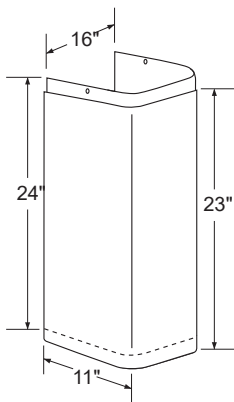

2-piece Decorative Duct Cover (dimension shown for reference only)

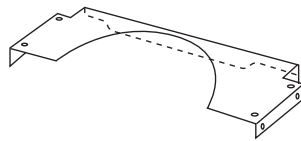

Duct Cover Bracket

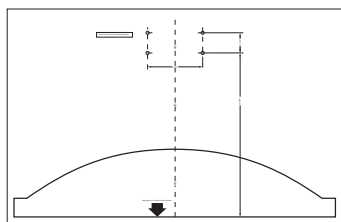

Wall Mount Template

DUCTWORK, WIRING LOCATIONS

Determine the exact location of the vent hood.

- Locate the template packed with the literature.

- Measure 36" from the floor to the top of the cooking surface. Add 25-1/2" (or other recommended space) from the cooking surface to the bottom of the hood. Mark that location.
- Use a level to draw a straight pencil line on the wall.

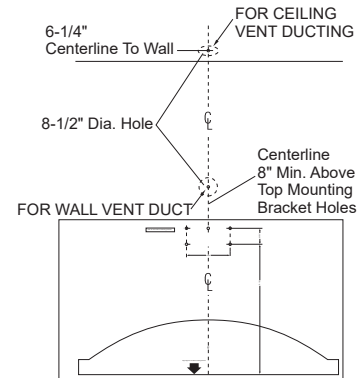

- Tape the template in position along the penciled line. CHECK TO BE SURE THE TEMPLATE IS LEVEL.

Ceiling ducting:

If ductwork will vent straight up to the ceiling:

- Use a level to draw a line straight up, from the centerline on the template to the ceiling.
- Measure 6-1/4" from the back wall to the centerline of a 8-1/2" hole on the ceiling.

NOTE: If drywall is not present, add drywall thickness to the 6-1/4" dimension.

Wall Ducting:

If ductwork will vent to the rear:

- Use the level to draw a line straight up from the centerline on the template.
- Measure at least 8" above the top mounting bracket holes shown on the template to the centerline of an 8-1/2" dia. duct hole. (Hole may be elongated for duct elbow.)

HOUSE WIRING LOCATION:

- The junction box is located on the top of the hood, at the back right side.
- Route house wiring as close to the ceiling location as possible, through the ceiling, soffit or back wall. Wiring should enter at least 4" above the bracket on the right side (no less than 18" above the planned lower edge of hood and ideally, 4" to the right of planned ductwork.)

Installation Instructions

1 INSTALL FRAMING FOR HOOD SUPPORT

IMPORTANT: Framing must be capable of supporting 100 lbs.

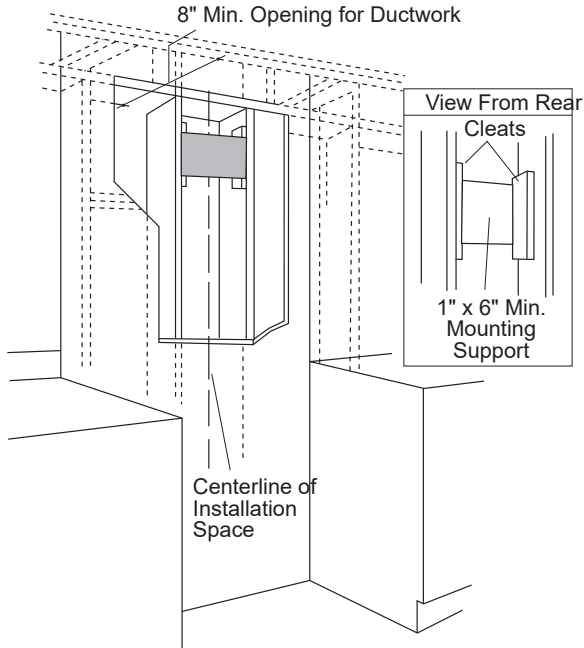

If drywall is present, mark the screw hole locations for the top mounting brackets. Remove the template.

- Cut away enough drywall to expose 2 vertical studs at the bracket location indicated on the template.
- Install a horizontal support at least 1" x 6" between two wall studs at the mounting screw location. **The horizontal support must be flush with the room side of the studs.** Use cleats behind both sides of the support to secure to wall studs.
- Reinstall drywall.

2 INSTALL MOUNTING BRACKET

This vent hood must be secured to the horizontal support or wall studs.

- With the template taped in place, use a punch to mark all mounting screw locations.
- Drill 1/8" pilot holes at the 6 punched locations.
- Remove the template.
- The 4 support bracket holes must enter studs or the horizontal support.

NOTE: Screws "A" and "B" are pre-assembled onto the brackets. Do not remove these screws.

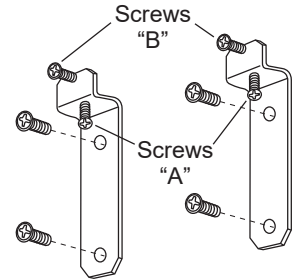

- Secure the mounting brackets to the wall studs with wood screws provided.

3 INSTALL DUCT BRACKET

The duct bracket must be installed against the ceiling. This bracket will hold the decorative duct cover in place at the top.

- Install the 2 small screws into the sides of the duct bracket. Remove the screws. Pre-tapping the holes will insure ease of final installation.

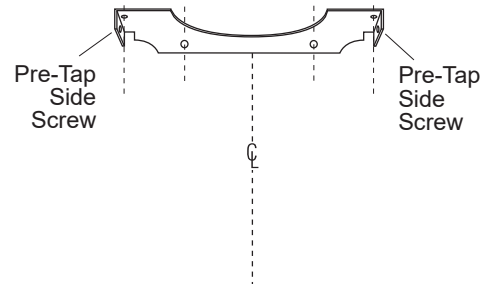

Secure the bracket to the ceiling and wall:

- Mark the 4 screw hole locations.
- Drill 1/8" pilot holes in marked bracket location.
- If pilot holes do not enter studs, enlarge the holes to 3/8" and install wall fastener anchors.
- Drive screws, by hand, into the fasteners to allow anchors to expand. Remove the screws.
- Secure the bracket to the ceiling and wall with wood screws and/or fasteners.

Installation Instructions

4 INSTALL THE HOOD

Place the hood on the brackets and slide left or right to center.

1. Adjust the installation levelness by tightening or loosening the screws "A" at the bottom of the brackets.
2. Mark the 2 lower mounting holes.
3. Remove the hood from the wall.
4. Drill a pilot hole in each lower mounting hole location. The two lower holes can be enlarged to 3/8" if they did enter studs. Tap anchors for wall fasteners into the bottom holes. Screws should be inserted by hand into the fasteners to allow anchors to expand against the wall material. Remove the screws for final installation.
5. Replace the hood on the mounting brackets.
6. Using two large flat washers (supplied), install wood screws or wall fastener screws.
7. Tighten screws "B" located at the top of the mounting bracket against the hood to clamp the position. Do not overtighten screws.

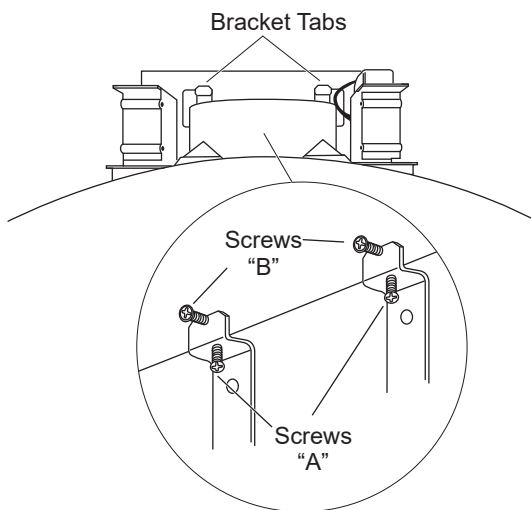

5 CONNECT DUCTWORK

- Install ductwork, making connections in direction of airflow as illustrated.
- Push duct over the exhaust outlet until it reaches the duct stops.
- Secure joints in ductwork with sheetmetal screws.
- Wrap all duct joints with duct tape for an airtight seal.
- Use duct tape to seal the flange connection.

CAUTION Do not use sheet metal screws at the hood flange connection. Doing so will prevent proper damper operations. Seal connection with tape only.

ATTENTION Il ne faut pas utiliser de vis autotaraudeuses à la connexion du collet de la hotte. Ceci empêcherait le bon fonctionnement du registre. N'utiliser que du ruban adhésif pour assurer l'étanchéité du raccord.

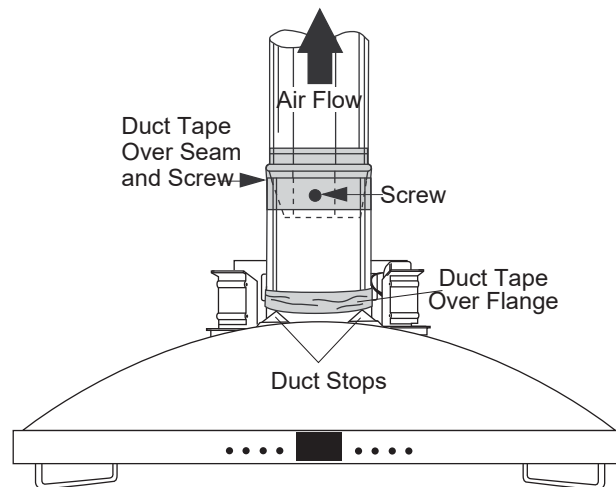

Installation Instructions

6 CONNECT ELECTRICAL

Verify that power is turned off at the source.

⚠ WARNING If house wiring is not 2-wire with a ground wire, a ground must be provided by the installer. When house wiring is aluminum, be sure to use U.L. approved anti-oxidant compound and aluminum-to-copper connectors.

⚠ AVERTISSEMENT Si la maison n'est pas câblée avec deux fils et un fil de terre, l'installateur doit installer un fil de terre. Quand les fils sont en aluminium, il faut prendre soin d'utiliser des connecteurs aluminium à cuivre avec une pâte antioxydante approuvée par U.L.

- Insert house wiring through strain relief and tighten.
- Connect white leads to branch circuit white lead.
- Connect black leads to branch circuit black lead.
- Connect green/yellow leads to branch circuit green lead or bare ground lead.
- Secure all connections with wire nuts on each electrical connector.
- Push wires into junction box and replace cover. Be sure wires are not pinched.

7 INSTALL DUCT COVERS

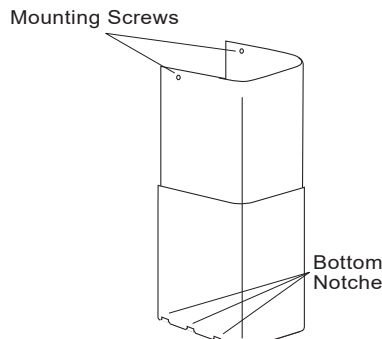
- Place the decorative duct covers on top of the hood. 
- Insert the lower portion of the duct cover into the impressions on the top of the hood.
- Extend the inner duct upwards to the ceiling bracket.
- Secure the duct cover to the bracket with the 2 small Phillips screws provided.

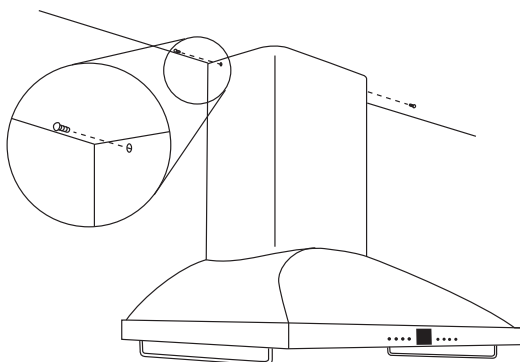

8 CONNECT ELECTRICAL

- Remove protective film on the filters.

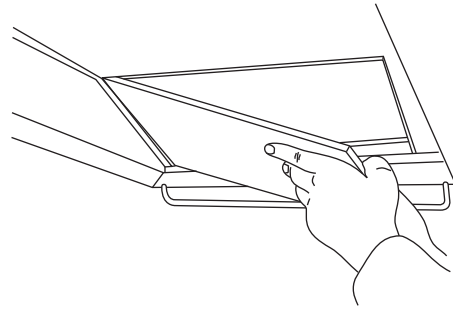

- Tip the filter into the slots at the rear of the opening. Lift the filter and pull the knob forward until the filter rests on the slots.
- Install all 3 grease filters.

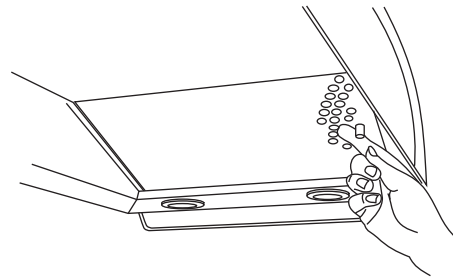

- To remove the filters, grasp the knob, push the filter towards the rear and tilt downwards.
- If the Clean Filter Reminder is glowing red after filters are installed, be sure to check the left side filter is making contact with the filter switch.

9 FINALIZE INSTALLATION

- Remove the protective film covering the control panel on the front face of the hood, and any other packaging materials.
- Refer to the Owner's Manual for operating instructions.

NOTE: While performing installations described in this book, safety glasses or goggles should be worn.

For Monogram® local service in your area, visit monogram.com.

NOTE: Product improvement is a continuing endeavor at Monogram Appliances. Therefore, materials, appearance and specifications are subject to change without notice.

