

JT3000DF

GE® Appliances 30" Built-In Single Wall Oven

DIMENSIONS AND INSTALLATION INFORMATION (IN INCHES)

MOST 30" WALL CABINETS CAN BE USED WITH THIS UNIT.

NOTE: These ovens are not approved for stackable installations. Cabinets installed adjacent to wall ovens must have an adhesion spec of at least a 194°F temperature rating.

Door handle protrudes 3" from door face. Cabinets and drawers on adjacent 45° and 90° walls should be placed to avoid interference with the handle.

Electric wall ovens are not approved for installation with a plug and receptacle. They must be hard wired in accordance with installation instructions.

INSTALLATION INFORMATION:

Before installing, consult installation instructions packed with product for current dimensional data.

Side-by-side installations require at least 2" between cutouts.

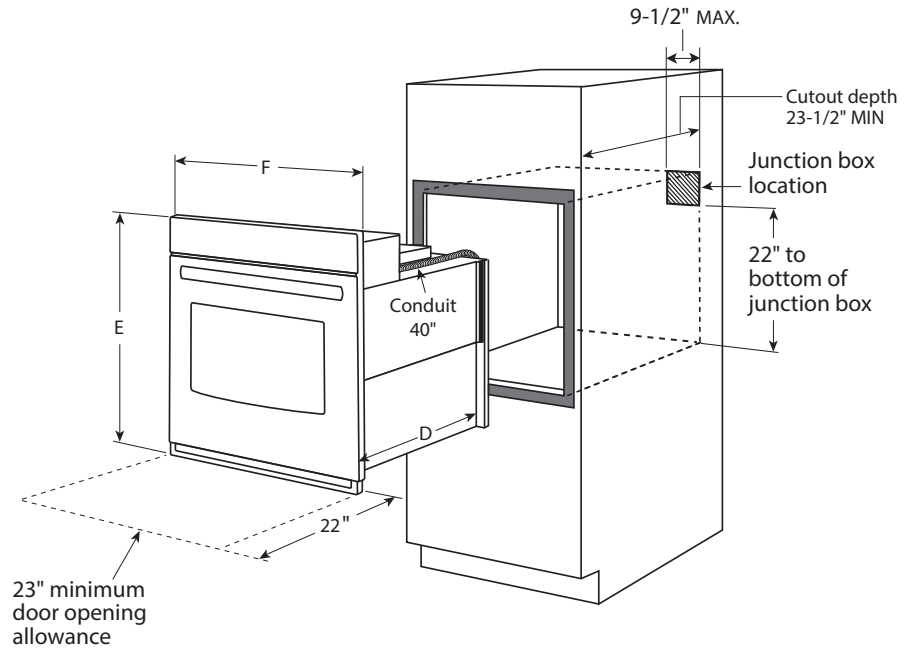
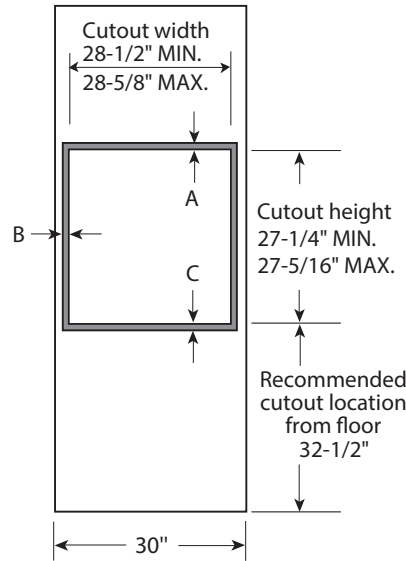

Dimension and installation information are shown in inches.

INSTALLATION BELOW A COOKTOP

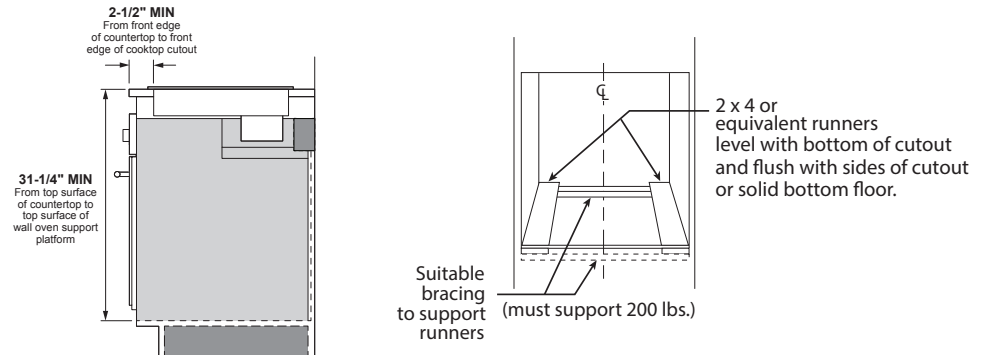

KW RATING	
240V	4.2
208V	3.2
BREAKER SIZE	
240V	20 Amps
208V	20 Amps

JT3000	
Cabinet	30"
A – Overlap of oven at top of cutout	1"
B – Overlap of oven over side of edges of cutout	3/4"
C – Overlap of oven at bottom of cutout	1-1/4"
Oven	
D – Install depth	23-1/2"
E – Overall height with trim	28-5/8"
F – Overall width	29-3/4"



For answers to your Monogram, GE Café™ Series, GE Profile™ Series or GE Appliances product questions, visit our website at geappliances.com or call GE Answer Center® Service, 800.626.2000.



Listed by Underwriters Laboratories



JT3000DF

GE® Appliances 30" Built-In Single Wall Oven

DIMENSIONS AND INSTALLATION INFORMATION (IN INCHES)

NOTE: 36" ribbon cooktop are approved for use over GE 30" single wall ovens and warming drawers. 30" ribbon cooktops are approved for use over 30" and GE 27" single wall ovens and warming drawers. Refer to cooktop and wall oven installation information packed with products for current dimensional data.

NOTE: Door handle protrudes 3" from door face. Cabinets and drawers on adjacent 45° and 90° walls should be placed to avoid interference with the handle.

INSTALLATION INFORMATION: Before installing, consult installation instructions packed with products for current dimensional data and for alternate installation options.

ELECTRIC WALL OVENS ARE NOT APPROVED FOR INSTALLATION WITH A PLUG AND RECEPTACLE. THEY MUST BE HARD WIRED IN ACCORDANCE WITH INSTALLATION INSTRUCTIONS.

Gas or electric cooktops may be installed over this oven. See cooktop installation instructions for cutout size. See label on top of oven for approved cooktop models.

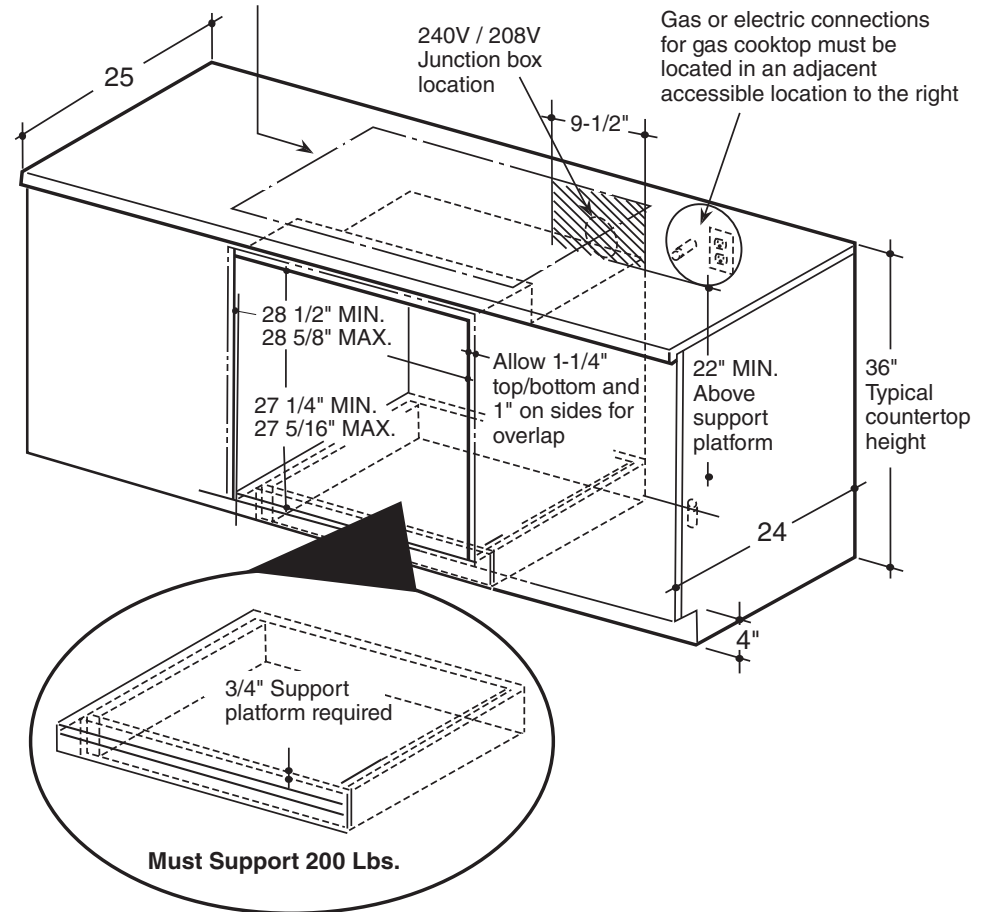

Dimension and installation information are shown in inches.



For answers to your Monogram, GE Café™ Series, GE Profile™ Series or GE Appliances product questions, visit our website at geappliances.com or call GE Answer Center® Service, 800.626.2000.



Listed by Underwriters Laboratories



Specification Revised 6/18

JT3000DF

GE® Appliances 30" Built-In Single Wall Oven

FEATURES AND BENEFITS

Self-clean with steam clean option – Clean your oven the way you want

Self-clean heavy-duty oven racks – Conveniently clean your oven and racks together

Ten-pass bake element – Even baking is assured with heat that covers more surface area

Eight-pass broil element – Get full broil coverage and even browning from edge to edge

5.0 cu. ft. oven capacity – Cook more dishes at once

Black gloss oven interior – Enjoy a clean and sleek appearance

Electronic touch controls – Confidently operate the oven with one easy touch

Hidden bake – Make cleanup easy by eliminating hard-to-reach areas

Audible preheat signal – Know when the oven is ready

Certified Sabbath mode – Prepare foods by kosher standards

Model JT3000DFBB – Black on black

Model JT3000DFWW – White on white

GUARANTEED FIT

Replacing a similar wall oven from GE or another brand? GE wall ovens are guaranteed for an exact fit to make replacement easy

Visit geappliances.com for more info

