



ge.com

# Microwave Oven

*Safety Instructions* . . . . .2-11

***Operating Instructions***

Auto Feature . . . . .21  
Care and Cleaning . . . . .30, 31  
Changing Power Level . . . . .14  
Features of Your  
Microwave Oven . . . . .12, 13  
Microwave Terms . . . . .29  
Other Features . . . . .26-28  
Sensor Features . . . . .22-25  
Time Features . . . . .15-20

***Troubleshooting Tips*** . . . .32, 33  
Things That Are Normal With  
Your Microwave Oven . . . . .33

***Consumer Support***

Consumer Support . .Back Cover  
Warranty . . . . .35

**Owner's Manual**

*JEM31*

**Write the model and serial numbers here:**

**Model #** \_\_\_\_\_

**Serial #** \_\_\_\_\_

You can find them on a label inside of the oven.



# **IMPORTANT SAFETY INFORMATION. READ ALL INSTRUCTIONS BEFORE USING.**

## **⚠ WARNING!**

For your safety, the information in this manual must be followed to minimize the risk of fire or explosion, electric shock, or to prevent property damage, personal injury, or loss of life.

## **PRECAUTIONS TO AVOID POSSIBLE EXPOSURE TO EXCESSIVE MICROWAVE ENERGY**



- **Do Not Attempt** to operate this oven with the door open since open-door operation can result in harmful exposure to microwave energy. It is important not to defeat or tamper with the safety interlocks.
- **Do Not Place** any object between the oven front face and the door or allow soil or cleaner residue to accumulate on sealing surfaces.
- **Do Not Operate** the oven if it is damaged. It is particularly important that the oven door close properly and that there is no damage to the:
  - 1 door (bent),
  - 2 hinges and latches (broken or loosened),
  - 3 door seals and sealing surfaces.
- **The Oven Should Not** be adjusted or repaired by anyone except properly qualified service personnel.



## **SAFETY PRECAUTIONS**

When using electrical appliances basic safety precautions should be followed, including the following:

- Read and follow the specific precautions in the *Precautions to Avoid Possible Exposure to Excessive Microwave Energy* section above.
- This appliance must be grounded. Connect only to a properly grounded outlet. See the *Grounding Instructions* section on page 8.
- Install or locate this appliance only in accordance with the provided Installation Instructions.
- Be certain to place the front surface of the door three inches or more back from the countertop edge to avoid accidental tipping of the appliance in normal usage.

*Use this appliance only for its intended purpose as described in this Owner's Manual.*

- This microwave oven is not approved or tested for marine use.
- Do not mount this appliance over a sink.
- Do not mount the microwave oven over or near any portion of a heating or cooking appliance.
- Do not store anything directly on top of the microwave oven surface when the microwave oven is in operation.
- Do not operate this appliance if it has a damaged power cord or plug, if it is not working properly, or if it has been damaged or dropped. If the power cord is damaged, it must be replaced by General Electric Service or an authorized service agent using a power cord available from General Electric.
- Do not cover or block any openings on the appliance.
- Use this appliance only for its intended use as described in this manual. Do not use corrosive chemicals or vapors in this appliance. This microwave oven is specifically designed to heat, dry or cook food, and is not intended for laboratory or industrial use.
- Do not store this appliance outdoors. Do not use this product near water—for example, in a wet basement, near a swimming pool, near a sink or in similar locations.
- Keep power cord away from heated surfaces.
- Do not immerse power cord or plug in water.
- Do not let power cord hang over edge of table or counter.
- To reduce the risk of fire in the oven cavity:
  - Do not overcook food. Carefully attend appliance when paper, plastic or other combustible materials are placed inside the oven while cooking.
  - Remove wire twist-ties and metal handles from paper or plastic containers before placing them in the oven.
  - Do not use the oven for storage purposes. Do not leave paper products, cooking utensils or food in the oven when not in use.
  - If materials inside the oven ignite, keep the oven door closed, turn the oven off and disconnect the power cord, or shut off power at the fuse or circuit breaker panel. If the door is opened, the fire may spread.
  - Do not use the Sensor Features twice in succession on the same food portion. If food is undercooked after the first countdown, use **Time Cook** for additional cooking time.
- See door surface cleaning instructions in the *Care and cleaning of the microwave oven* section of this manual.
- This appliance must only be serviced by qualified service personnel. Contact nearest authorized service facility for examination, repair or adjustment.
- As with any appliance, close supervision is necessary when used by children.

# **IMPORTANT SAFETY INFORMATION. READ ALL INSTRUCTIONS BEFORE USING.**

## **⚠ WARNING!**



### *ARCING*

*If you see arcing, press the **CLEAR/OFF** pad and correct the problem.*

Arcing is the microwave term for sparks in the oven. Arcing is caused by:

- Metal or foil touching the side of the oven.
- Foil not molded to food (upturned edges act like antennas).
- Metal, such as twist-ties, poultry pins, or gold-rimmed dishes, in the microwave.
- Recycled paper towels containing small metal pieces being used in the microwave.



### *FOODS*

- Do not pop popcorn in your microwave oven unless in a special microwave popcorn accessory or unless you use popcorn labeled for use in microwave ovens.
- Some products such as whole eggs and sealed containers—for example, closed jars—are able to explode and should not be heated in this microwave oven. Such use of the microwave oven could result in injury.
- Do not boil eggs in a microwave oven. Pressure will build up inside egg yolk and will cause it to burst, possibly resulting in injury.
- Operating the microwave with no food inside for more than a minute or two may cause damage to the oven and could start a fire. It increases the heat around the magnetron and can shorten the life of the oven.
- Foods with unbroken outer “skin” such as potatoes, hot dogs, sausages, tomatoes, apples, chicken livers and other giblets, and egg yolks should be pierced to allow steam to escape during cooking.

### ■ **SUPERHEATED WATER**

*Liquids, such as water, coffee or tea, are able to be overheated beyond the boiling point without appearing to be boiling. Visible bubbling or boiling when the container is removed from the microwave oven is not always present. THIS COULD RESULT IN VERY HOT LIQUIDS SUDDENLY BOILING OVER WHEN THE CONTAINER IS DISTURBED OR A SPOON OR OTHER UTENSIL IS INSERTED INTO THE LIQUID.*

To reduce the risk of injury to persons:

- Do not overheat the liquid.
  - Stir the liquid both before and halfway through heating it.
  - Do not use straight-sided containers with narrow necks.
  - After heating, allow the container to stand in the microwave oven for a short time before removing the container.
  - Use extreme care when inserting a spoon or other utensil into the container.
- Avoid heating baby food in glass jars, even with the lid off. Make sure all infant food is thoroughly cooked. Stir food to distribute the heat evenly. Be careful to prevent scalding when warming formula. The container may feel cooler than the formula really is. Always test the formula before feeding the baby.
  - Don't defrost frozen beverages in narrow-necked bottles (especially carbonated beverages). Even if the container is opened, pressure can build up. This can cause the container to burst, possibly resulting in injury.
  - Hot foods and steam can cause burns. Be careful when opening any containers of hot food, including popcorn bags, cooking pouches and boxes. To prevent possible injury, direct steam away from hands and face.
  - Do not overcook potatoes. They could dehydrate and catch fire, causing damage to your oven.
  - Cook meat and poultry thoroughly—meat to at least an INTERNAL temperature of 160°F and poultry to at least an INTERNAL temperature of 180°F. Cooking to these temperatures usually protects against foodborne illness.

# **IMPORTANT SAFETY INFORMATION. READ ALL INSTRUCTIONS BEFORE USING.**

## **⚠ WARNING!**



### *MICROWAVE-SAFE COOKWARE*

Make sure all cookware used in your microwave oven is suitable for microwaving. Most glass casseroles, cooking dishes, measuring cups, custard cups, pottery or china dinnerware which does not have metallic trim or glaze with a metallic sheen can be used. Some cookware is labeled “suitable for microwaving.”

- If you are not sure if a dish is microwave-safe, use this test: Place in the oven both the dish you are testing and a glass measuring cup filled with 1 cup of water—set the measuring cup either in or next to the dish. Microwave 30–45 seconds at high. If the dish heats, it should not be used for microwaving.

If the dish remains cool and only the water in the cup heats, then the dish is microwave-safe.

- If you use a meat thermometer while cooking, make sure it is safe for use in microwave ovens.
- Do not use recycled paper products. Recycled paper towels, napkins and waxed paper can contain metal flecks which may cause arcing or ignite. Paper products containing nylon or nylon filaments should be avoided, as they may also ignite.
- Some styrofoam trays (like those that meat is packaged on) have a thin strip of metal embedded in the bottom. When microwaved, the metal can burn the floor of the oven or ignite a paper towel.
- Do not use the microwave to dry newspapers.
- Not all plastic wrap is suitable for use in microwave ovens. Check the package for proper use.
- Paper towels, waxed paper and plastic wrap can be used to cover dishes in order to retain moisture and prevent spattering. Be sure to vent plastic wrap so steam can escape.
- Cookware may become hot because of heat transferred from the heated food. Pot holders may be needed to handle the cookware.

- “Boilable” cooking pouches and tightly closed plastic bags should be slit, pierced or vented as directed by package. If they are not, plastic could burst during or immediately after cooking, possibly resulting in injury. Also, plastic storage containers should be at least partially uncovered because they form a tight seal. When cooking with containers tightly covered with plastic wrap, remove covering carefully and direct steam away from hands and face.
- Use foil only as directed in this guide. TV dinners may be microwaved in foil trays less than 3/4” high; remove the top foil cover and return the tray to the box. When using foil in the microwave oven, keep the foil at least 1” away from the sides of the oven.
- Plastic cookware—Plastic cookware designed for microwave cooking is very useful, but should be used carefully. Even microwave-safe plastic may not be as tolerant of overcooking conditions as are glass or ceramic materials and may soften or char if subjected to short periods of overcooking. In longer exposures to overcooking, the food and cookware could ignite.

*Follow these guidelines:*

- 1 Use microwave-safe plastics only and use them in strict compliance with the cookware manufacturer’s recommendations.
- 2 Do not microwave empty containers.
- 3 Do not permit children to use plastic cookware without complete supervision.

# **IMPORTANT SAFETY INFORMATION. READ ALL INSTRUCTIONS BEFORE USING.**

## **⚠ WARNING!**

*Improper use of the grounding plug can result in a risk of electric shock.*



## **GROUNDING INSTRUCTIONS**

This appliance must be grounded. In the event of an electrical short circuit, grounding reduces the risk of electric shock by providing an escape wire for the electric current.

This appliance is equipped with a power cord having a grounding wire with a grounding plug. The plug must be plugged into an outlet that is properly installed and grounded.

Consult a qualified electrician or service technician if the grounding instructions are not completely understood, or if doubt exists as to whether the appliance is properly grounded.

If the outlet is a standard 2-prong wall outlet, it is your personal responsibility and obligation to have it replaced with a properly grounded 3-prong wall outlet.

Do not under any circumstances cut or remove the third (ground) prong from the power cord.

We do not recommend using an extension cord with this appliance. If the power cord is too short, have a qualified electrician or service technician install an outlet near the appliance. (See **WARNING—EXTENSION CORDS** section.)

For best operation, plug this appliance into its own electrical outlet to prevent flickering of lights, blowing of fuse or tripping of circuit breaker.



## ADAPTER PLUGS

**Usage situations where appliance's power cord will be disconnected infrequently.**

Because of potential safety hazards under certain conditions, **we strongly recommend against the use of an adapter plug.** However, if you still elect to use an adapter, where local codes permit, a **TEMPORARY CONNECTION** may be made to a properly grounded 2-prong wall receptacle by the use of a UL-listed adapter which is available at most local hardware stores.

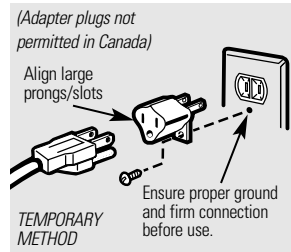

The larger slot in the adapter must be aligned with the larger slot in the wall receptacle to provide proper polarity in the connection of the power cord.

**CAUTION:** Attaching the adapter ground terminal to the wall receptacle cover screw does not ground the appliance unless the cover screw is metal, and not insulated, and the wall receptacle is grounded through the house wiring.

You should have the circuit checked by a qualified electrician to make sure the receptacle is properly grounded.

When disconnecting the power cord from the adapter, always hold the adapter with one hand. If this is not done, the adapter ground terminal is very likely to break with repeated use. Should this happen, **DO NOT USE** the appliance until a proper ground has again been established.

**Usage situations where appliance's power cord will be disconnected frequently.**

**Do not use an adapter plug** in these situations because frequent disconnection of the power cord places undue strain on the adapter and leads to eventual failure of the adapter ground terminal. You should have the 2-prong wall receptacle replaced with a 3-prong (grounding) receptacle by a qualified electrician before using the appliance.

# ***IMPORTANT SAFETY INFORMATION. READ ALL INSTRUCTIONS BEFORE USING.***

## **⚠ WARNING!**

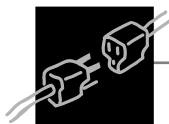

### *EXTENSION CORDS*

A short power supply cord is provided to reduce the risks resulting from becoming entangled in or tripping over a longer cord.

Extension cords may be used if you are careful in using them.

If an extension cord is used—

- 1** The marked electrical rating of the extension cord should be at least as great as the electrical rating of the appliance;
- 2** The extension cord must be a grounding-type 3-wire cord and it must be plugged into a 3-slot outlet;
- 3** The extension cord should be arranged so that it will not drape over the countertop or tabletop where it can be pulled on by children or tripped over unintentionally.

If you use an extension cord, the interior light may flicker and the blower sound may vary when the microwave oven is on. Cooking times may be longer, too.



*READ AND FOLLOW THIS SAFETY  
INFORMATION CAREFULLY.*

***SAVE THESE INSTRUCTIONS***

## About the features of your microwave oven.

Throughout this manual, features and appearance may vary from your model.

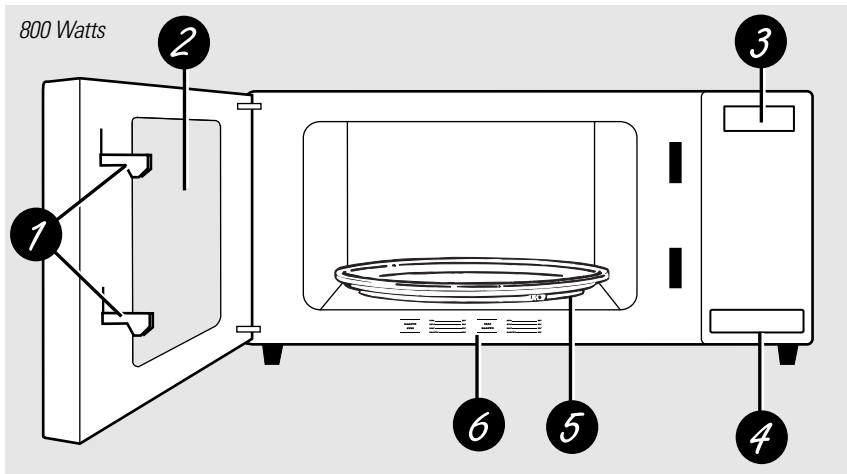

### Features of the Oven

- 1** **Door Latches.**
- 2** **Window with Metal Shield.** Screen allows cooking to be viewed while keeping microwaves confined in the oven.
- 3** **Touch Control Panel Display.**
- 4** **Door Latch Release.** Press latch release to open door.
- 5** **Removable Turntable.** Turntable and support **must** be in place when using the oven. The turntable may be removed for cleaning.
- 6** **Convenience Guide.**

**NOTE:** Rating plate, oven vent(s) and oven light are located on the inside walls of the microwave oven.

### Optional Accessories

Available at extra cost from your GE supplier.

**04-A019 Hanging Kit** allows this oven to be mounted under a cabinet.

**JX827 27" Built-In Kit** allows this oven to be built into a cabinet or wall.

You can microwave by time, with the sensor features or with the auto feature.

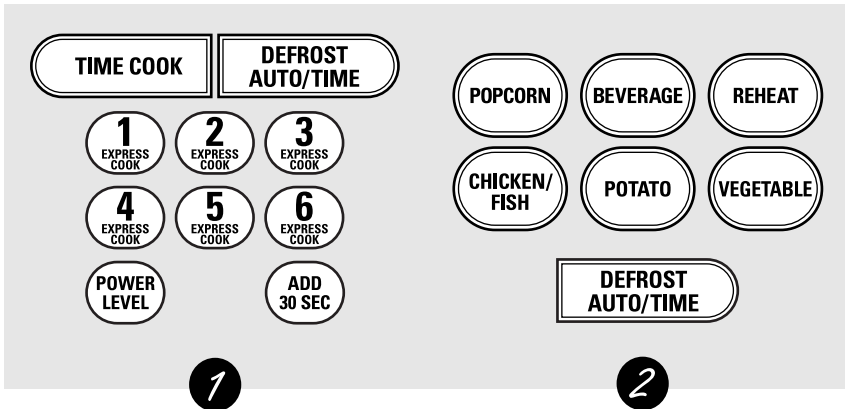

## Cooking Controls

Check the Convenience Guide before you begin.

1

### Time Features

Press	Enter
<b>TIME COOK</b> Press once or twice	Amount of cooking time
<b>DEFROST AUTO/TIME</b> Press twice	Amount of defrosting time
<b>EXPRESS COOK</b>	Starts immediately!
<b>ADD 30 SEC</b>	Starts immediately!
<b>POWER LEVEL</b>	Power level 1–10

2

### Sensor Features and Auto Feature

Press	Enter	Option
<b>POPCORN</b>	Starts immediately!	more/less time
<b>BEVERAGE</b>	Starts immediately!	
<b>REHEAT</b>	Starts immediately!	more/less time
<b>CHICKEN/FISH</b> Press once (chicken pieces) Press twice (fish fillets)	Starts immediately!	more/less time
<b>POTATO</b>	Starts immediately!	more/less time
<b>VEGETABLE</b> Press once (fresh vegetables) Press twice (frozen vegetables) Press three times (canned vegetables)	Starts immediately!	more/less time more/less time more/less time (on some models)
<b>DEFROST AUTO/TIME</b> Press once	Food weight	

## About changing the power level.

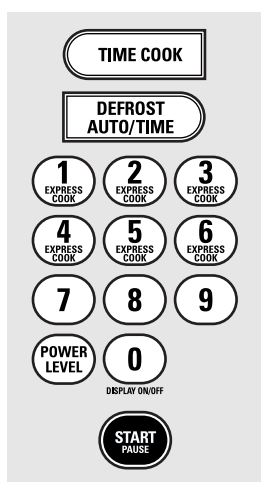

The power level may be entered or changed immediately after entering the feature time for **TIME COOK**, **TIME DEFROST** or **EXPRESS COOK**. The power level may also be changed during time countdown.

- 1 Press **TIME COOK** or select **Time Defrost**.
- 2 Enter cooking or defrosting time.
- 3 Press **POWER LEVEL**.
- 4 Select desired power level 1–10.
- 5 Press **START**.

Variable power levels add flexibility to microwave cooking. The power levels on the microwave oven can be compared to the surface units on a range. Each power level gives you microwave energy a certain percent of the time. **Power level 7** is microwave energy 70% of the time. **Power level 3** is energy 30% of the time. Most cooking will be done on **High (power level 10)** which gives you 100% power. **Power level 10** will cook faster but food may need more frequent stirring, rotating or turning over. A lower setting will cook more evenly and need less stirring or rotating of the food. Some foods may have better flavor, texture or appearance if one of the lower settings is used. Use a lower power level when cooking foods that have a tendency to boil over, such as scalloped potatoes.

Rest periods (when the microwave energy cycles off) give time for the food to “equalize” or transfer heat to the inside of the food. An example of this is shown with **power level 3**—the defrost cycle. If microwave energy did not cycle off, the outside of the food would cook before the inside was defrosted.

*Here are some examples of uses for various power levels:*

**High 10:** Fish, bacon, vegetables, boiling liquids.

**Med-High 7:** Gentle cooking of meat and poultry; baking casseroles and reheating.

**Medium 5:** Slow cooking and tenderizing for stews and less tender cuts of meat.

**Low 2 or 3:** Defrosting; simmering; delicate sauces.

**Warm 1:** Keeping food warm; softening butter.

# About the time features.

ge.com

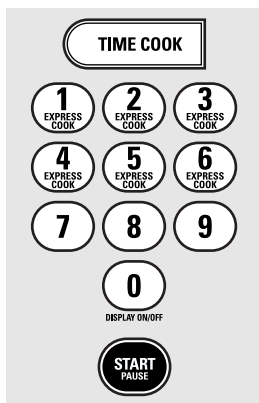

## Time Cook

### Time Cook I

Allows you to microwave for any time up to 99 minutes and 99 seconds.

**Power level 10 (High)** is automatically set, but you may change it for more flexibility.

- 1 Press **TIME COOK**.
- 2 Enter cooking time.
- 3 Change power level if you don't want full power. (Press **POWER LEVEL**. Select a desired power level 1–10.)
- 4 Press **START**.

You may open the door during **Time Cook** to check the food. Close the door and press **START** to resume cooking.

### Time Cook II

Lets you change power levels automatically during cooking. Here's how to do it:

- 1 Press **TIME COOK**.
- 2 Enter the first cook time.
- 3 Change the power level if you don't want full power. (Press **POWER LEVEL**. Select a desired power level 1–10.)
- 4 Press **TIME COOK** again.
- 5 Enter the second cook time.
- 6 Change the power level if you don't want full power. (Press **POWER LEVEL**. Select a desired power level 1–10.)
- 7 Press **START**.

At the end of **Time Cook I**, **Time Cook II** counts down.

## About the time features.

### Cooking Guide for Time Cook

**NOTE:** Use **power level High (10)** unless otherwise noted.

<b>Vegetable</b>	<b>Amount</b>	<b>Time</b>	<b>Comments</b>
<b>Asparagus</b> (fresh spears)	1 lb.	7 to 10 min., Med-High (7)	In 1½-qt. oblong glass baking dish, place 1/4 cup water.
(frozen spears)	10-oz. package	5 to 8 min.	In 1-qt. casserole.
<b>Beans</b> (fresh green)	1 lb. cut in half	12 to 17 min.	In 1½-qt. casserole, place 1/2 cup water.
(frozen green)	10-oz. package	5 to 9 min.	In 1-qt. casserole, place 2 tablespoons water.
(frozen lima)	10-oz. package	5 to 9 min.	In 1-qt. casserole, place 1/4 cup water.
<b>Beets</b> (fresh, whole)	1 bunch	18 to 25 min.	In 2-qt. casserole, place 1/2 cup water.
<b>Broccoli</b> (fresh cut)	1 bunch (1¼ to 1½ lbs.)	7 to 10 min.	In 2-qt. casserole, place 1/2 cup water.
(fresh spears)	1 bunch (1¼ to 1½ lbs.)	9 to 13 min.	In 2-qt. oblong glass baking dish, place 1/4 cup water.
(frozen, chopped)	10-oz. package	5 to 8 min.	In 1-qt. casserole.
(frozen spears)	10-oz. package	5 to 8 min.	In 1-qt. casserole, place 3 tablespoons water.
<b>Cabbage</b> (fresh)	1 medium head (about 2 lbs.)	8 to 11 min.	In 1½- or 2-qt. casserole, place 1/4 cup water.
(wedges)		7 to 10 min.	In 2- or 3-qt. casserole, place 1/4 cup water.
<b>Carrots</b> (fresh, sliced)	1 lb.	6 to 9 min.	In 1½-qt. casserole, place 1/4 cup water.
(frozen)	10-oz. package	5 to 8 min.	In 1-qt. casserole, place 2 tablespoons water.
<b>Cauliflower</b> (flowerets)	1 medium head	9 to 14 min.	In 2-qt. casserole, place 1/2 cup water.
(fresh, whole)	1 medium head	9 to 17 min.	In 2-qt. casserole, place 1/2 cup water.
(frozen)	10-oz. package	5 to 8 min.	In 1-qt. casserole, place 2 tablespoons water.



<b>Vegetable</b>	<b>Amount</b>	<b>Time</b>	<b>Comments</b>
<b>Corn</b> (frozen kernel)	10-oz. package	4 to 8 min.	In 1-qt. casserole, place 2 tablespoons water.
<b>Corn on the cob</b> (fresh)	1 to 5 ears	3 to 5 min. per ear	In 2-qt. oblong glass baking dish, place corn. If corn is in husk, use no water; if corn has been husked, add 1/4 cup water. Rearrange after half of time.
(frozen)	1 ear 2 to 6 ears	5 to 7 min. 2 to 4 min. per ear	Place in 2-qt. oblong glass baking dish. Cover with vented plastic wrap. Rearrange after half of time.
<b>Mixed vegetables</b> (frozen)	10-oz. package	4 to 8 min.	In 1-qt. casserole, place 3 tablespoons water.
<b>Peas</b> (fresh, shelled)	2 lbs. unshelled	9 to 12 min.	In 1-qt. casserole, place 1/4 cup water.
(frozen)	10-oz. package	4 to 8 min.	In 1-qt. casserole, place 2 tablespoons water.
<b>Potatoes</b> (fresh, cubed, white)	4 potatoes (6 to 8 oz. each)	11 to 14 min.	Peel and cut into 1-inch cubes. Place in 2-qt. casserole with 1/2 cup water. Stir after half of time.
(fresh, whole, sweet or white)	1 (6 to 8 oz.)	2 to 5 min.	Pierce with cooking fork. Place in center of the oven. Let stand 5 minutes.
<b>Spinach</b> (fresh)	10 to 16 oz.	5 to 8 min.	In 2-qt. casserole, place washed spinach.
(frozen, chopped and leaf)	10-oz. package	5 to 8 min.	In 1-qt. casserole, place 3 tablespoons water.
<b>Squash</b> (fresh, summer and yellow)	1 lb. sliced	4 to 7 min.	In 1½-qt. casserole, place 1/4 cup water.
(winter, acorn or butternut)	1 or 2 squash (about 1 lb. each)	7 to 11 min.	Cut in half and remove fibrous membranes. In 2-qt. oblong glass baking dish, place squash cut-side-down. Turn cut-side-up after 4 minutes.

## About the time features.

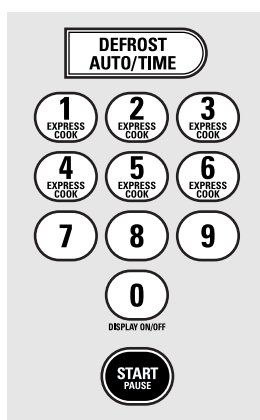

### Time Defrost

Allows you to defrost for a selected length of time. See the *Defrosting Guide* for suggested times. (**Auto Defrost** explained in the *About the auto feature* section.)

- 1 Press **DEFROST AUTO/TIME** twice.
- 2 Enter defrosting time.
- 3 Press **START**.
- 4 Turn food over when the oven signals.
- 5 Press **START**.

Power level is automatically set at 3, but can be changed. You can defrost small items quickly by raising the power level after entering the time. **Power level 7** cuts the total defrosting time in about half; **power level 10** cuts the total time to approximately 1/3. However, food will need more frequent attention than usual.

At one half of selected defrosting time, the oven signals **TURN**. At this time, turn food over and break apart or rearrange pieces for more even defrosting. Shield any warm areas with small pieces of foil.

A dull thumping noise may be heard during defrosting. This is normal when oven is not operating at **High** power.

### Defrosting Tips

- Foods frozen in paper or plastic can be defrosted in the package. Closed packages should be slit, pierced or vented **AFTER** food has partially defrosted. Plastic storage containers should be partially uncovered.
- Family-size, prepackaged frozen dinners can be defrosted and microwaved. If the food is in a foil container, transfer it to a microwave-safe dish.
- Foods that spoil easily should not be allowed to sit out for more than one hour after defrosting. Room temperature promotes the growth of harmful bacteria.
- For more even defrosting of larger foods, such as roasts, use **Auto Defrost**. Be sure large meats are completely defrosted before cooking.
- When defrosted, food should be cool but softened in all areas. If still slightly icy, return to the microwave very briefly or let it stand a few minutes.

## Defrosting Guide

<b>Food</b>	<b>Time</b>	<b>Comments</b>
<b>Breads, Cakes</b>		
<i>Bread, buns or rolls (1 piece)</i>	1/2 min.	
<i>Sweet rolls (approx. 12 oz.)</i>	2 to 4 min.	
<b>Fish and Seafood</b>		
<i>Fillets, frozen (1 lb.)</i>	8 to 12 min.	
<i>Shellfish, small pieces (1 lb.)</i>	5 to 8 min.	Place block in casserole. Turn over and break up after half the time.
<b>Fruit</b>		
<i>Plastic pouch – 1 or 2 (10-oz. package)</i>	3 to 7 min.	
<b>Meat</b>		
<i>Bacon (1 lb.)</i>	3 to 6 min.	Place unopened package in oven. Let stand 5 minutes after defrosting.
<i>Franks (1 lb.)</i>	3 to 6 min.	Place unopened package in oven. Microwave just until franks can be separated. Let stand 5 minutes, if necessary, to complete defrosting.
<i>Ground meat (1 lb.)</i>	5 to 8 min.	Turn meat over after half the time.
<i>Roast: beef, lamb, veal, pork</i>	10 to 16 min. per lb.	Use <b>power level 1</b> .
<i>Steaks, chops and cutlets</i>	5 to 10 min. per lb.	Place unwrapped meat in cooking dish. Turn over after half the time and shield warm areas with foil. When finished, separate pieces and let stand to complete defrosting.
<b>Poultry</b>		
<i>Chicken, broiler-fryer cut up (2½ to 3 lbs.)</i>	16 to 22 min.	Place wrapped chicken in dish. Unwrap and turn over after half the time. When finished, separate pieces and microwave 2–4 minutes more, if necessary. Let stand to finish defrosting.
<i>Chicken, whole (2½ to 3 lbs.)</i>	22 to 28 min.	Place wrapped chicken in dish. After half the time, unwrap and turn chicken over. Shield warm areas with foil. Finish defrosting. If necessary, run cold water in the cavity until giblets can be removed.
<i>Cornish hen</i>	9 to 16 min. per lb.	Place unwrapped hen in the oven breast-side-up. Turn over after half the time. Run cool water in the cavity until giblets can be removed.
<i>Turkey breast (4 to 6 lbs.)</i>	5 to 10 min. per lb.	Place unwrapped breast in dish breast-side-down. After half the time, turn over and shield warm areas with foil. Finish defrosting. Let stand 1–2 hours in refrigerator to complete defrosting.

## About the time features.

---



### **Express Cook**

*This is a quick way to set cooking time for 1–6 minutes.*

Press one of the **Express Cook** pads (from 1 to 6) for 1 to 6 minutes of cooking at **power level 10**. For example, press the **2** pad for 2 minutes of cooking time.

The power level can be changed as time is counting down. Press **POWER LEVEL** and enter 1–10.

---



### **Add 30 Seconds**

*You can use this feature two ways:*

- It will add 30 seconds to the time counting down each time the pad is pressed.
- It can be used as a quick way to set 30 seconds of cooking time.

# About the auto feature.

ge.com

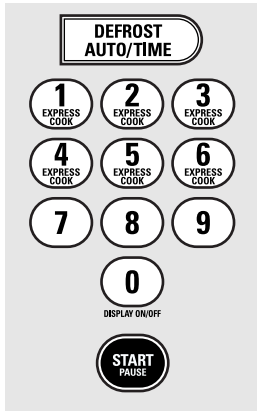

## Auto Defrost

The **Defrost Auto/Time** feature gives you two ways to defrost frozen foods. Press **DEFROST AUTO/TIME** once for **Auto Defrost** or twice for **Time Defrost**.

Use **Auto Defrost** for meat, poultry and fish. Use **Time Defrost** for most other frozen foods.

**Auto Defrost** automatically sets the defrosting times and power levels to give even defrosting results for meats, poultry and fish weighing up to 6 pounds.

- 1 Press **DEFROST AUTO/TIME** once.
- 2 Using the *Conversion Guide* below, enter food weight. For example, press pads **1** and **2** for 1.2 pounds (1 pound, 3 ounces).
- 3 Press **START**.

(**Time Defrost** is explained in the *About the time features* section.)

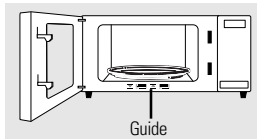

There is a handy guide located on the inside front of the oven.

- Remove meat from package and place on microwave-safe dish.
- Twice during defrost, the oven signals **TURN**. At each **TURN** signal, turn the food over. Remove defrosted meat or shield warm areas with small pieces of foil.
- After defrosting, most meats need to stand 5 minutes to complete defrosting. Large roasts should stand for about 30 minutes.

## Conversion Guide

If the weight of food is stated in pounds and ounces, the ounces must be converted to tenths (.1) of a pound.

Weight of Food in Ounces	Enter Food Weight (tenths of a pound)
1-2	.1
3	.2
4-5	.3
6-7	.4
8	.5
9-10	.6
11	.7
12-13	.8
14-15	.9

## About the sensor features.

### Humidity Sensor

The **Sensor Features** detect the increasing humidity released during cooking. The oven automatically adjusts the cooking time to various types and amounts of food.

Do not use the Sensor Features twice in succession on the same food portion—it may result in severely overcooked or burnt food. If food is undercooked after the countdown, use **Time Cook** for additional cooking time.

- The proper containers and covers are essential for best sensor cooking.

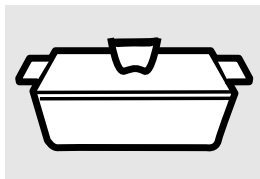

Covered

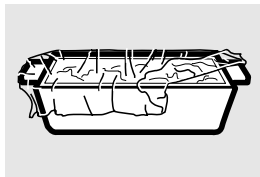

Vented



Dry off dishes so they don't mislead the sensor.

- Always use microwave-safe containers and cover them with lids or vented plastic wrap. Never use tight-sealing plastic containers—they can prevent steam from escaping and cause food to overcook.
- Be sure the outside of the cooking containers and the inside of the microwave oven are dry before placing food in the oven. Beads of moisture turning into steam can mislead the sensor.



Use only with prepackaged microwave popcorn weighing 3.0 to 3.5 ounces.

**NOTE:** Do not use this feature twice in succession on the same food portion—it may result in severely overcooked or burnt food.

## Popcorn

To use the **Popcorn** feature:

**1** Follow package instructions, using **Time Cook** if the package is less than 3.0 ounces or larger than 3.5 ounces. Place the package of popcorn in the center of the microwave.

**2** Press **POPCORN**. The oven starts immediately.

If you open the door while **POPCORN** is displayed, **SENSOR ERROR** will appear. Close the door, press **CLEAR/OFF** and begin again.

During the **POPCORN** cycle, the turntable will rotate, stop, then rotate again. This feature provides optimum results.

If food is undercooked after the countdown use **Time Cook** for additional cooking time.

### **How to Adjust the Popcorn Program to Provide a Shorter or Longer Cook Time**

If you find that the brand of popcorn you use underpops or overcooks consistently, you can add or subtract 20–30 seconds to the automatic popping time.

*To add time:*

After pressing **POPCORN**, press **9** immediately after the oven starts for an extra 20 seconds. Press **9** again to add another 10 seconds (total 30 seconds additional time).

*To subtract time:*

After pressing **POPCORN**, press **1** immediately after the oven starts for 20 seconds less cooking time. Press **1** again to reduce cooking time another 10 seconds (total 30 seconds less time).



**NOTE:** Do not use this feature twice in succession on the same food portion—it may result in severely overcooked or burnt food.

## Beverage

Press **BEVERAGE** to heat a cup of coffee or other beverage.

**Drinks heated with the Beverage feature may be very hot. Remove the container with care.**

If food is undercooked after the countdown use **Time Cook** for additional cooking time.

## About the sensor features.



### How to Change the Automatic Settings

To reduce time by 10%:

Press **1** after the feature pad.

To add 10% to cooking time:

Press **9** after the feature pad.

**NOTE:** Do not use this feature twice in succession on the same food portion—it may result in severely overcooked or burnt food.

### Reheat

The **Reheat** feature reheats single servings of previously cooked foods or a plate of leftovers.

**1** Place covered food in the oven. Press **REHEAT**. The oven starts immediately.

**2** The oven signals when steam is sensed and the time remaining begins counting down.

Do not open the oven door until time is counting down. If the door is opened, close it and press **START** immediately.

**After removing food from the oven, stir, if possible, to even out the temperature. Reheated foods may have wide variations in temperature. Some areas may be extremely hot.**

If food is not hot enough after the countdown, use **Time Cook** for additional reheating time.

### Some Foods Not Recommended for Use With Reheat

It is best to use **Time Cook** for these foods:

- Bread products.
- Foods that must be reheated uncovered.
- Foods that need to be stirred or rotated.
- Foods calling for a dry look or crisp surface after reheating.





(less time) (more time)

Sensor cooking gives you easy, automatic results with a variety of foods (see the Cooking Guide below).

**NOTE:** Do not use this feature twice in succession on the same food portion—it may result in severely overcooked or burnt food.

## Sensor Cooking

### Vegetables, Potatoes, Fish, Chicken Pieces

- 1 Place covered food in the oven. Press the food pad. For vegetables, press the **VEGETABLE** pad once for fresh vegetables, twice for frozen vegetables or three times for canned vegetables. For chicken or fish, press the **CHICKEN/FISH** pad once for chicken pieces or twice for fish. The oven starts immediately.
- 2 The oven signals when steam is sensed and the time remaining begins counting down. Turn or stir the food if necessary.

Do not open the oven door until time is counting down. If the door is opened, close it and press **START** immediately.

If food is undercooked after the countdown, use **Time Cook** for additional cooking time.

### How to Change the Automatic Settings (automatic settings for canned vegetables cannot be adjusted on some models):

You can adjust the cooking time for all foods to suit your personal taste.

*To reduce time by 10%:*

Press **1** within 30 seconds after pressing the food pad.

*To add 10% to cooking time:*

Press **9** within 30 seconds after pressing the food pad.

## Cooking Guide

Food Type	Amount	Comments
<b>Canned Vegetables</b>	4–16 oz	Cover with lid or vented plastic wrap.
<b>Frozen Vegetables</b>	4–16 oz	Follow package instructions for adding water. Cover with lid or vented plastic wrap.
<b>Fresh Vegetables</b>	4–16 oz	Add 1/4 cup water per serving. Cover with lid or vented plastic wrap.
<b>Potatoes</b>	1/2–2 lbs	Pierce skin with fork. Place potatoes on the turntable.
<b>Fish</b>	4–16 oz	Cover with vented plastic wrap.
<b>Chicken Pieces</b>	1–8 pieces	Cover with vented plastic wrap.

## About the other features.



### Help

The **HELP** pad displays feature information and helpful hints. Press **HELP**, then select a feature pad.

### Cooking Complete Reminder

To remind you that you have food in the oven, the oven will display **FOOD IS READY** and beep once a minute until you either open the oven door or press **CLEAR/OFF**.

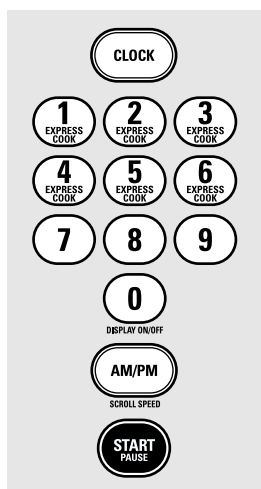

### Clock

Press to enter the time of day or to check the time of day while microwaving.

- 1 Press **CLOCK**.
- 2 Enter time of day.
- 3 Select AM or PM.
- 4 Press **START** or **CLOCK**.



### Scroll Speed

The scroll speed of the display can be changed. Press and hold the **AM/PM** pad about 3 seconds to bring up the display. Select 1–5 for slow to fast scroll speed.



### Start/Pause

In addition to starting many functions, **START/PAUSE** allows you to stop cooking without opening the door or clearing the display.

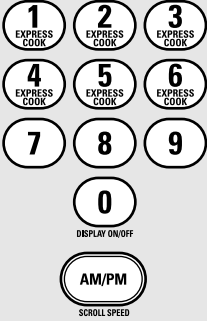

 A rectangular button with rounded corners and a double border, containing the word "REMINDER" in a bold, sans-serif font.

## Reminder

The **Reminder** feature can be used like an alarm clock and can be used at any time, even when the oven is operating. The **Reminder** time can be set up to 24 hours later.

- 1 Press **REMINDER**.
- 2 Enter the time you want the oven to remind you. (Be sure the microwave clock shows the correct time of day.)
- 3 Select AM or PM.
- 4 Press **REMINDER**. When **Reminder** signal occurs, press **REMINDER** to turn it off. The **Reminder** time may be displayed by pressing **REMINDER**.

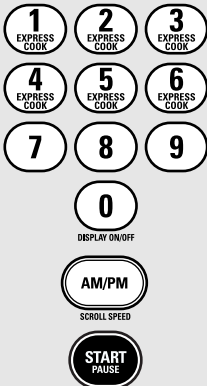
**NOTE:** The **REM** indicator will remain lit to show that the **Reminder** is set. To clear the **Reminder** before it occurs, press **REMINDER**, then **0**. The **REM** indicator will no longer be lit.

 A rectangular button with rounded corners and a double border, containing the words "DELAY START" in a bold, sans-serif font.

## Delay Start

**Delay Start** allows you to set the microwave to delay cooking up to 24 hours.

- 1 Press **DELAY START**.
- 2 Enter the time you want the oven to start. (Be sure the microwave clock shows the correct time of day.)
- 3 Select AM or PM.
- 4 Select any combination of **Defrost Auto/Time** and **Time Cook**.
- 5 Press **START**.

The **Delay Start** time will be displayed plus **DS**. The oven will automatically start at the delayed time.

The time of day may be displayed by pressing **CLOCK**.

## About the other features.



### Child Lock-Out

You may lock the control panel to prevent the microwave from being accidentally started or used by children.

To lock or unlock the controls, press and hold **CLEAR/OFF** for about three seconds. When the control panel is locked, an **L** will be displayed to the extreme right.



### Turntable

For best cooking results, leave the turntable on. It can be turned off for large dishes. Press **TURNTABLE** to turn the turntable on or off.

**Sometimes the turntable can become too hot to touch.** Be careful touching the turntable during and after cooking.

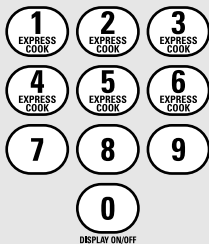

### Timer On/Off

**Timer On/Off** operates as a minute timer and can be used at any time, even when the oven is operating.

- 1 Press **TIMER ON/OFF**.
- 2 Enter time you want to count down.
- 3 Press **TIMER ON/OFF** to start.

When time is up, the oven will signal. To turn off the timer signal, press **TIMER ON/OFF**.

**NOTE:** The timer indicator will be lit while the timer is operating.



### Display On/Off

To turn the clock display on or off, press and hold **0** for about 3 seconds. The **Display On/Off** feature cannot be used while a cooking feature is in use.

<b>Term</b>	<b>Definition</b>
<b>Arcing</b>	Arcing is the microwave term for sparks in the oven. Arcing is caused by: <ul style="list-style-type: none"><li>■ metal or foil touching the side of the oven.</li><li>■ foil that is not molded to food (upturned edges act like antennas).</li><li>■ metal such as twist-ties, poultry pins, gold-rimmed dishes.</li><li>■ recycled paper towels containing small metal pieces.</li></ul>
<b>Covering</b>	Covers hold in moisture, allow for more even heating and reduce cooking time. Venting plastic wrap or covering with wax paper allows excess steam to escape.
<b>Shielding</b>	In a regular oven, you shield chicken breasts or baked foods to prevent over-browning. When microwaving, you use small strips of foil to shield thin parts, such as the tips of wings and legs on poultry, which would cook before larger parts.
<b>Standing Time</b>	When you cook with regular ovens, foods such as roasts or cakes are allowed to stand to finish cooking or to set. Standing time is especially important in microwave cooking. Note that a microwaved cake is not placed on a cooling rack.
<b>Venting</b>	After covering a dish with plastic wrap, you vent the plastic wrap by turning back one corner so excess steam can escape.

## Care and cleaning of the microwave oven.



### Helpful Hints

An occasional thorough wiping with a solution of baking soda and water keeps the inside fresh.

**Unplug the cord before cleaning any part of this oven.**

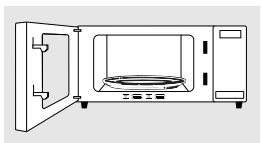

### How to Clean the Inside

#### **Walls, Floor, Inside Window, Metal and Plastic Parts on the Door**

Some spatters can be removed with a paper towel; others may require a damp cloth. Remove greasy spatters with a sudsy cloth, then rinse with a damp cloth. Do not use abrasive cleaners or sharp utensils on oven walls.

*To clean the surface of the door and the surface of the oven that come together upon closing, use only mild, nonabrasive soaps or detergents using a sponge or soft cloth. Rinse with a damp cloth and dry.*

**Never use a commercial oven cleaner on any part of your microwave.**

#### **Removable Turntable and Turntable Support**

To prevent breakage, do not place the turntable into water just after cooking. Wash it carefully in warm, sudsy water or in the dishwasher. The turntable and support can be broken if dropped. Remember, do not operate the oven without the turntable and support in place.

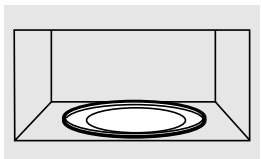

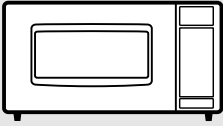

## **How to Clean the Outside**

***Do not use cleaners containing ammonia or alcohol on the microwave oven. Ammonia or alcohol can damage the appearance of the microwave.***

### **Case**

Clean the outside of the microwave with a sudsy cloth. Rinse and then dry. Wipe the window clean with a damp cloth.

### **Control Panel and Door**

Wipe with a damp cloth. Dry thoroughly. Do not use cleaning sprays, large amounts of soap and water, abrasives or sharp objects on the panel—they can damage it. Some paper towels can also scratch the control panel.

### **Door Surface**

It's important to keep the area clean where the door seals against the microwave. Use only mild, non-abrasive detergents applied with a clean sponge or soft cloth. Rinse well.

### **Stainless Steel (on some models)**

*Do not use a steel-wood pad; it will scratch the surface.*

To clean the stainless steel surface, use a hot, damp cloth with a mild detergent suitable for stainless steel surfaces. Use a clean, hot, damp cloth to remove soap. Dry with a dry, clean cloth. Always scrub lightly in the direction of the grain.

## Before you call for service...



### Troubleshooting Tips

Save time and money! Review the charts on the following pages first and you may not need to call for service.

<b>Problem</b>	<b>Possible Causes</b>	<b>What To Do</b>
<b>Oven will not start</b>	A fuse in your home may be blown or the circuit breaker tripped.	<ul style="list-style-type: none"> <li>• Replace fuse or reset circuit breaker.</li> </ul>
	Power surge.	<ul style="list-style-type: none"> <li>• Unplug the microwave oven, then plug it back in.</li> </ul>
	Plug not fully inserted into wall outlet.	<ul style="list-style-type: none"> <li>• Make sure the 3-prong plug on the oven is fully inserted into wall outlet.</li> </ul>
	Door not securely closed.	<ul style="list-style-type: none"> <li>• Open the door and close securely.</li> </ul>
<b>Control panel lighted, yet oven will not start</b>	Door not securely closed.	<ul style="list-style-type: none"> <li>• Open the door and close securely.</li> </ul>
	<b>START</b> pad not pressed after entering cooking selection.	<ul style="list-style-type: none"> <li>• Press <b>START</b>.</li> </ul>
	Another selection entered already in oven and <b>CLEAR/OFF</b> pad not pressed to cancel it.	<ul style="list-style-type: none"> <li>• Press <b>CLEAR/OFF</b>.</li> </ul>
	Cooking time not entered after pressing <b>TIME COOK</b> .	<ul style="list-style-type: none"> <li>• Make sure you have entered cooking time after pressing <b>TIME COOK</b>.</li> </ul>
	<b>CLEAR/OFF</b> was pressed accidentally.	<ul style="list-style-type: none"> <li>• Reset cooking program and press <b>START</b>.</li> </ul>
	Food weight not entered after selecting <b>Auto Defrost</b> .	<ul style="list-style-type: none"> <li>• Make sure you have entered food weight after selecting <b>Auto Defrost</b>.</li> </ul>
<b>"SENSOR ERROR" appears on display</b>	During <b>Popcorn, Reheat, Beverage, Chicken/Fish, Potato, or Vegetable</b> program, the door was opened before steam could be detected.	<ul style="list-style-type: none"> <li>• Close the door, press <b>CLEAR/OFF</b> and begin again.</li> </ul>
	Steam was not detected in maximum amount of time.	<ul style="list-style-type: none"> <li>• Use <b>Time Cook</b> to heat for more time.</li> </ul>



<b>Problem</b>	<b>Possible Causes</b>	<b>What To Do</b>
<b>"LOCKED" appears in display</b>	The control has been locked. (When the control panel is locked, an <b>L</b> will be displayed.)	<ul style="list-style-type: none"> <li>• Press and hold <b>CLEAR/OFF</b> for about three seconds to unlock the control.</li> </ul>
<b>Food amount too large for Sensor Reheat</b>	<b>Sensor Reheat</b> is for single servings of recommended foods.	<ul style="list-style-type: none"> <li>• Use <b>Time Cook</b> for large amounts of food.</li> </ul>

### **Things That Are Normal With Your Microwave Oven**

- Steam or vapor escaping from around the door.
- Light reflection around door or outer case.
- Dimming oven light and change in the blower sound at power levels other than high.
- Dull thumping sound while oven is operating.
- Turntable starts and stops automatically during **POPCORN**.
- TV/radio interference might be noticed while using the microwave. Similar to the interference caused by other small appliances, it does not indicate a problem with the microwave. Plug the microwave into a different electrical circuit, move the radio or TV as far away from the microwave as possible, or check the position and signal of the TV/radio antenna.

**Notes.**

---

## GE Microwave Oven Warranty.



All warranty service provided by our Factory Service Centers, or an authorized Customer Care® technician. To schedule service, on-line, 24 hours a day, visit us at [ge.com](http://ge.com), or call 800.GE.CARES (800.432.2737). Please have serial and model numbers available when calling for service.

Staple your receipt here. Proof of the original purchase date is needed to obtain service under the warranty.

<b>For The Period Of:</b>	<b>GE Will Replace:</b>
<b>One Year</b> From the date of the original purchase	<b>Any part</b> of the microwave oven which fails due to a defect in materials or workmanship. During this <b>limited one-year warranty</b> , GE will also provide, <b>free of charge</b> , all labor and related service to replace the defective part.
<b>Five Years</b> From the date of original purchase	<b>The magnetron tube</b> , if the magnetron tube fails due to a defect in materials or workmanship. During this <b>five-year limited warranty</b> , you will be responsible for any labor or in-home service costs.

**For each of the above limited warranties:** To avoid any trip charges, you must take the microwave oven to a General Electric Customer Care® servicer and pick it up following service. In-home service is also available, but you must pay for the service technician's travel costs to your home.

### What GE Will Not Cover:

- Service trips to your home to teach you how to use the product.
- Improper installation, delivery or maintenance.
- Product not accessible to provide required service.
- Failure of the product or damage to the product if it is abused, misused (for example, cavity arcing from wire rack or metal/foil), or used for other than the intended purpose or used commercially.
- Replacement of house fuses or resetting of circuit breakers.
- Damage to the product caused by accident, fire, floods or acts of God.
- Incidental or consequential damage caused by possible defects with this appliance.
- Damage caused after delivery.

**EXCLUSION OF IMPLIED WARRANTIES—Your sole and exclusive remedy is product repair as provided in this Limited Warranty. Any implied warranties, including the implied warranties of merchantability or fitness for a particular purpose, are limited to one year or the shortest period allowed by law.**

This warranty is extended to the original purchaser and any succeeding owner for products purchased for home use within the USA. If the product is located in an area where service by a GE Authorized Servicer is not available, you may be responsible for a trip charge or you may be required to bring the product to an Authorized GE Service Location for service. In Alaska, the warranty excludes the service calls to your home.

Some states do not allow the exclusion or limitation of incidental or consequential damages. This warranty gives you specific legal rights, and you may also have other rights which vary from state to state. To know what your legal rights are, consult your local or state consumer affairs office or your state's Attorney General.

# Consumer Support.

---



## GE Appliances Website

[ge.com](http://ge.com)

Have a question or need assistance with your appliance? Try the GE Appliances Website 24 hours a day, any day of the year! For greater convenience and faster service, you can now download Owner's Manuals, order parts, catalogs, or even schedule service on-line. You can also "Ask Our Team of Experts"<sup>SM</sup> your questions, and so much more...



## Schedule Service

[ge.com](http://ge.com)

Expert GE repair service is only one step away from your door. Get on-line and schedule your service at your convenience 24 hours any day of the year! Or call 800.GE.CARES (800.432.2737) during normal business hours.



## Real Life Design Studio

[ge.com](http://ge.com)

GE supports the Universal Design concept—products, services and environments that can be used by people of all ages, sizes and capabilities. We recognize the need to design for a wide range of physical and mental abilities and impairments. For details of GE's Universal Design applications, including kitchen design ideas for people with disabilities, check out our Website today. For the hearing impaired, please call 800.TDD.GEAC (800.833.4322).



## Extended Warranties

[ge.com](http://ge.com)

Purchase a GE extended warranty and learn about special discounts that are available while your warranty is still in effect. You can purchase it on-line anytime, or call 800.626.2224 during normal business hours. GE Consumer Home Services will still be there after your warranty expires.

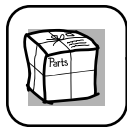

## Parts and Accessories

[ge.com](http://ge.com)

Individuals qualified to service their own appliances can have parts or accessories sent directly to their homes (VISA, MasterCard and Discover cards are accepted). Order on-line today, 24 hours every day or by phone at 800.626.2002 during normal business hours.

**Instructions contained in this manual cover procedures to be performed by any user. Other servicing generally should be referred to qualified service personnel. Caution must be exercised, since improper servicing may cause unsafe operation.**



## Contact Us

[ge.com](http://ge.com)

If you are not satisfied with the service you receive from GE, contact us on our Website with all the details including your phone number, or write to:

General Manager, Customer Relations  
GE Appliances, Appliance Park  
Louisville, KY 40225



## Register Your Appliance

[ge.com](http://ge.com)

**Register your new appliance on-line—at your convenience!** Timely product registration will allow for enhanced communication and prompt service under the terms of your warranty, should the need arise. You may also mail in the pre-printed registration card included in the packing material.