

# Owner's Manual

Side-by-Side  
Stainless Steel  
Free-Standing  
Refrigerators



*Introduction*

Your new Monogram refrigerator makes an eloquent statement of style, convenience and kitchen planning flexibility. Whether you chose it for its purity of design, practical storage arrangements or assiduous attention to detail—or for all of these reasons—you'll find that your Monogram refrigerator's superior blend of form and function will delight you for years to come.

The information on the following pages will help you operate and maintain your refrigerator properly.

If you have any other questions, visit our Website at: [www.monogram.com](http://www.monogram.com)

*Contents*

**Consumer Services**

Important Phone Numbers ..... 31

Model and Serial Numbers..... 3

Performance Data Sheet ..... 28

Problem Solver..... 23–27

Product Registration..... 3

Safety Instructions ..... 4–7

State of California

Warranty ..... Back Cover

Water Treatment Device Certificate ..... 29

**Care and Cleaning**

Cleaning—Outside and Inside ..... 20

Light Bulb Replacement ..... 22

Moving ..... 21

Vacation..... 21

**Operating Instructions**

Additional Features..... 15

Automatic Icemaker.....17, 18

Crispers and Pans ..... 16

CustomCool™ .....10, 11

Ice and Water Dispenser..... 19

Performance Air Flow System..... 8

Shelves and Bins .....13, 14

Temperature Controls ..... 8

TurboCool™ ..... 9

Water Filter ..... 12

*Before using your refrigerator*

Read this manual carefully. It is intended to help you operate and maintain your new refrigerator properly.

Keep it handy for answers to your questions.

If you don't understand something or need more help, there is a list of toll-free consumer service numbers included in the back section of this manual.

**OR**

Visit our Website at: [www.monogram.com](http://www.monogram.com)

*Write down the model & serial numbers*

You'll see them on a label inside the fresh food compartment at the top on the right side.

Please write these numbers on the Consumer Product Ownership Registration Card included with the packing material.

**Before sending in this card, please also write these numbers here:**

Model Number

Serial Number

Use these numbers in any correspondence or service calls concerning your refrigerator.

*If you received a damaged refrigerator*

Immediately contact the dealer (or builder) that sold you the refrigerator.

*Save time & money*

Before you request service, check the Problem Solver in the back of this manual.

It lists causes of minor operating problems that you can correct yourself.

*If you need service*

To obtain service, see the Consumer Services page in the back of this manual.

We're proud of our service and want you to be pleased. If for some reason you are not happy with the service you receive, here are steps to follow for further help.

**For customers in the USA:**

FIRST, contact the people who serviced your appliance. Explain why you are not pleased. In most cases, this will solve the problem.

NEXT, if you are still not pleased, write all the details—including your phone number—to:

Manager, Customer Relations  
GE Appliances  
Appliance Park  
Louisville, KY 40225

**For customers in Canada:**

FIRST, contact the people who serviced your appliance. Explain why you are not pleased. In most cases, this will solve the problem.

NEXT, if you are still not pleased, write all the details—including your phone number to:

Manager, Consumer Relations  
Mabe Canada Inc.  
1 Factory Lane, Suite 310  
Moncton, N.B. E1C 9M3

# IMPORTANT SAFETY INSTRUCTIONS

---

## READ AND SAVE THESE INSTRUCTIONS

**⚠ WARNING:** *When using this appliance, always exercise basic safety precautions, including the following:*

- **Use this appliance only for its intended purpose** as described in this Owner's Manual.
- **This refrigerator must be properly installed in accordance with the Installation Instructions before it is used.**
- **Do not allow children to climb, stand or hang on the shelves in the refrigerator.** They could damage the refrigerator and seriously injure themselves.
- **Do not touch the cold surfaces in the freezer compartment when hands are damp or wet.** Skin may adhere to these extremely cold surfaces.
- **Do not store or use gasoline or other flammable vapors and liquids in the vicinity of this or any other appliance.**
- **In refrigerators with automatic icemakers,** avoid contact with moving parts of the ejector mechanism, or with the heating element located on the bottom of the icemaker. Do not place fingers or hands on the automatic icemaking mechanism while the refrigerator is plugged in.
- **Keep fingers out of the "pinch point" areas:** clearances between the doors and between the doors and cabinet are necessarily small. Be careful closing doors when children are in the area.
- **Unplug your refrigerator before cleaning and making repairs.** **NOTE:** We strongly recommend that any servicing be performed by a qualified individual.
- **Before replacing a burned-out light bulb,** the refrigerator should be unplugged in order to avoid contact with a live wire filament. (A burned-out light bulb may break when being replaced.)  
**NOTE:** Turning control to OFF does not remove power to the light circuit.
- **Do not refreeze frozen foods which have thawed completely.**
- **Always clean the CustomCool™ Tray after thawing food.**

---

## **⚠ DANGER: RISK OF CHILD ENTRAPMENT**

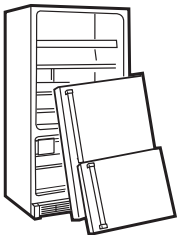

Child entrapment and suffocation are not problems of the past. Junked or abandoned refrigerators are still dangerous...even if they will sit for "just a few days." If you are getting rid of your old refrigerator, please follow the instructions below to help prevent accidents.

### **Before You Throw Away Your Old Refrigerator or Freezer:**

- Take off the doors.
- Leave the shelves in place so that children may not easily climb inside.

---

## REFRIGERANTS

All refrigeration products contain refrigerants, which under federal law must be removed prior to product disposal.

If you are getting rid of an old refrigeration product, check with the company handling the disposal about what to do.

# MESURES DE SÉCURITÉ IMPORTANTES

## LIRE ET CONSERVER CES INSTRUCTIONS

**⚠ AVERTISSEMENT :** Lorsque vous utilisez le réfrigérateur, observez toujours certaines précautions de base, notamment :

- **N'utilisez le réfrigérateur que pour son usage prévu**, comme décrit dans le présent manuel.
- **Installez le réfrigérateur conformément aux directives d'installation avant de l'utiliser.**
- **Ne laissez pas les enfants grimper, s'asseoir, se tenir debout ni se pendre aux clayettes du réfrigérateur.** Ils pourraient endommager le réfrigérateur et se blesser gravement.
- **Une fois le réfrigérateur en marche, ne touchez pas les surfaces froides du congélateur, surtout si vous avez les mains humides ou mouillées :** la peau risque d'adhérer à ces surfaces très froides.
- **N'entreposez et n'utilisez pas d'essence ou autres vapeurs et liquides inflammables à proximité de cet appareil ou de tout autre appareil électroménager.**
- **Pour les réfrigérateurs dotés d'une machine à glaçons automatique**, évitez le contact avec les pièces mobiles du mécanisme éjecteur, ou avec l'élément chauffant situé à la partie inférieure de la machine à glaçons. Ne posez pas les doigts ou les mains sur le mécanisme de la machine à glaçons pendant que le réfrigérateur est branché.

- **Éloignez les doigts des parties du réfrigérateur où l'on peut facilement se pincer :** les espaces entre les portes et entre les portes et les placards sont toujours étroits. Soyez prudent lorsque vous fermez les portes de l'appareil en présence des enfants.
- **Débranchez votre réfrigérateur avant de le nettoyer et de le réparer.** **REMARQUE :** Nous vous recommandons vivement de confier toute réparation à un technicien qualifié.
- **Avant de remplacer une ampoule grillée**, le réfrigérateur doit être débranché afin d'éviter tout contact avec un fil sous tension. (Une ampoule grillée peut se briser pendant l'opération).  
**REMARQUE :** Lorsque vous placez la commande sur éteint, l'alimentation électrique de l'ampoule n'est pas coupée.
- **Ne faites PAS recongeler des aliments surgelés qui ont complètement dégelé.**
- **Nettoyez toujours le contenant CustomCool™ après avoir dégelé les aliments.**

## ⚠ DANGER: RISQUES POUR LES ENFANTS

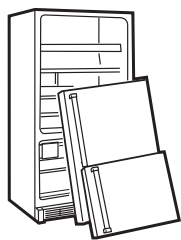

Les enfants pris au piège ou morts d'asphyxie sont toujours d'actualité. Les appareils de réfrigération abandonnés sont toujours aussi dangereux, même si on n'attend que "quelque jours" pour s'en débarrasser. Si vous ne gardez pas votre ancien appareil, veuillez suivre les directives ci-dessous afin de prévenir les accidents.

**Avant de vous débarrasser de votre vieux appareil de réfrigération :**

- Démontez les portes.
- Laissez les clayettes en place afin d'empêcher les enfants de grimper à l'intérieur.

## RÉFRIGÉRANTS

Tous les appareils de réfrigération contiennent des réfrigérants qui, conformément aux lois fédérales, doivent être enlevés avant toute élimination de l'appareil.

Si vous vous débarrassez de vieux appareils de réfrigération, vérifiez, auprès de la société qui s'occupe de leur élimination, ce que vous devez faire.

# IMPORTANT SAFETY INSTRUCTIONS

---

## HOW TO CONNECT ELECTRICITY

***Do not, under any circumstances, cut or remove the third (ground) prong from the power cord. For personal safety, this appliance must be properly grounded.***

The power cord of this appliance is equipped with a 3-prong (grounding) plug which mates with a standard 3-prong (grounding) wall outlet to minimize the possibility of electric shock hazard from this appliance.

Have the wall outlet and circuit checked by a qualified electrician to make sure the outlet is properly grounded.

Where a standard 2-prong wall outlet is encountered, it is your personal responsibility and obligation to have it replaced with a properly grounded 3-prong wall outlet.

The refrigerator should always be plugged into its own individual electrical outlet which has a voltage rating that matches the rating plate.

This provides the best performance and also prevents overloading house wiring circuits which could cause a fire hazard from overheated wires.

Never unplug your refrigerator by pulling on the power cord. Always grip plug firmly and pull straight out from the outlet.

Repair or replace immediately all power cords that have become frayed or otherwise damaged. Do not use a cord that shows cracks or abrasion damage along its length or at either end.

When moving the refrigerator away from the wall, be careful not to roll over or damage the power cord.

---

## USE OF ADAPTER PLUGS *(Adapter plugs not permitted in Canada)*

***Because of potential safety hazards under certain conditions, we strongly recommend against the use of an adapter plug.***

However, if you must use an adapter, where local codes permit, a **temporary connection** may be made to a properly grounded 2-prong wall outlet by use of a UL-listed adapter available at most local hardware stores.

The larger slot in the adapter must be aligned with the larger slot in the wall outlet to provide proper polarity in the connection of the power cord.

When disconnecting the power cord from the adapter, always hold the adapter in place with one hand while pulling the power cord plug with the other hand. If this is not done, the adapter ground terminal is very likely to break with repeated use.

If the adapter ground terminal breaks, **DO NOT USE** the appliance until a proper ground has been established.

Attaching the adapter ground terminal to a wall outlet cover screw does not ground the appliance unless the cover screw is metal, and not insulated, and the wall outlet is grounded through the house wiring. You should have the circuit checked by a qualified electrician to make sure the outlet is properly grounded.

Use of an adapter plug will increase the clearance needed for the back of the appliance.

---

## USE OF EXTENSION CORDS

***Because of potential safety hazards under certain conditions, we strongly recommend against the use of an extension cord.***

However, if you must use an extension cord, it is absolutely necessary that it be a UL-listed, 3-wire grounding type appliance extension cord having a grounding type plug and outlet and that the electrical rating of the cord be 15 amperes (minimum) and 120 volts.

## SAVE THESE INSTRUCTIONS

## RACCORDEMENT ÉLECTRIQUE

**Ne coupez ni retirez en aucun cas la troisième broche (mise à la terre) de la fiche du cordon d'alimentation. Pour votre sécurité, cet appareil doit être correctement mis à la terre.**

Le cordon d'alimentation de cet appareil est muni d'une fiche à 3 broches (mise à la terre) qui se branche dans une prise mural ordinaire à 3 alvéoles (mise à la terre) pour réduire au minimum les risques du chocs électriques.

Faites examiner la prise de courant et le circuit par un électricien qualifié pour vous assurer que la prise est correctement mise à la terre.

Si la prise murale est du type standard à 2 alvéoles, il vous incombe de la faire remplacer par une prise à 3 alvéoles correctement mise à la terre.

La machine à glaçons doit toujours être branché dans sa propre prise de courant, dont la tension nominale est identique à celle indiquée sur la plaque signalétique.

Cette précaution est recommandée pour garantir un rendement optimum et éviter une surcharge des circuits électriques de la résidence, ce qui pourrait créer un risque d'incendie par surschauffe des fils.

Ne débranchez jamais l'appareil en tirant le cordon d'alimentation. Saisissez fermement la fiche du cordon et tirez droit pour la retirer de la prise.

Réparez ou remplacez immédiatement tout cordon effiloché ou endommagé. N'utilisez pas un cordon fendillé ou présentant des signes d'usure.

Lorsque vous déplacez l'appareil du mur, faites attention de ne pas la faire rouler sur le cordon d'alimentation afin de ne pas l'endommager.

## FICHE D'ADAPTATION (Fiches d'adaptation non permises au Canada)

**Nous vous recommandons fortement de ne pas utiliser une fiche d'adaptation à cause des risques potentiels qu'elle présente dans certaines circonstances.**

Toutefois, si vous décidez d'utiliser tout de même une fiche d'adaptation, vous pouvez effectuer un **raccordement temporaire**, si les codes locaux le permettent, dans une prise de courant à 2 alvéoles adéquatement mise à la terre en utilisant une fiche d'adaptation homologuée UL, en vente dans la plupart des quincailleries.

La fente la plus longue de la fiche doit être alignée avec la fente la plus longue de la prise murale afin d'assurer la polarité appropriée pour le branchement du cordon d'alimentation.

Lorsque vous débranchez le cordon d'alimentation de la fiche d'adaptation, saisissez toujours la fiche d'une main pendant que vous tirez sur la fiche du cordon d'alimentation de l'autre. Sinon, la borne de mise à la terre de la fiche d'adaptation risque de casser avec le temps.

Si la borne de mise à la terre de la fiche casse, **N'UTILISEZ PAS** l'appareil tant qu'une mise à la terre adéquate n'aura pas été rétablie.

Le fait de fixer la borne de mise à la terre de la fiche d'adaptation à la plaque de la prise de courant n'assure pas automatiquement la mise à la terre de l'appareil. Il faut que la vis soit en métal, non isolée, et que la prise de courant soit mise à la terre par l'entremise du câblage de résidence. Faites vérifier le circuit par un électricien qualifié pour vous assurer que la prise est adéquatement mise à la terre.

## CORDONS PROLONGATEURS

**Nous vous recommandons fortement de ne pas utiliser de cordons prolongateurs à cause des risques potentiels qu'ils présentent dans certaines conditions.**

Toutefois si vous décidez d'utiliser tout de même un cordon prolongateur, il est absolument nécessaire

qu'il s'agisse d'un cordon à 3 fils avec mise à la terre pour appareils électroménagers homologué UL (aux États-Unis) ou homologué CSA (au Canada), pourvu d'une fiche et d'une prise mises à la terre de 15 ampères (minimum) et de 120 volts.

## CONSERVEZ CES DIRECTIVES

### Temperature controls

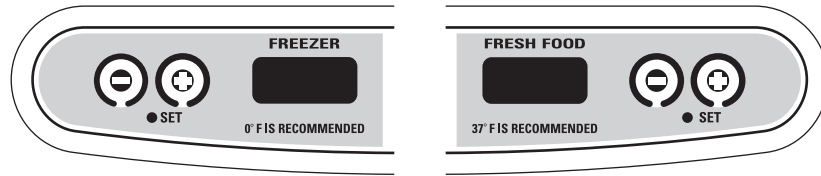





The temperature controls are preset in the factory at **37°F** for the fresh food compartment and **0°F** for the freezer compartment. Allow 24 hours for the temperature to stabilize to the preset recommended settings.



The temperature controls can display both the **SET** temperature as well as the actual temperature in the fresh food and freezer compartments. The actual temperature may vary slightly from the **SET** temperature based on usage and operating environment.

Setting either or both controls to **OFF** stops cooling in both the freezer and fresh food compartments, but does not shut off electrical power to the refrigerator.

**NOTE:** The refrigerator is shipped with protective film covering the temperature controls. If this film was not removed during installation, remove it now.

**To change the temperature,** press and release the  (warmer) or  (colder) pad. The SET light will come on and the display will show the set temperature. To change the temperature, tap either the  (warmer) or  (colder) pad until the desired temperature is displayed. Fresh food temperatures can be adjusted between 34°F and 44°F and the freezer temperatures can be adjusted between -6°F and +6°F.

Once the desired temperature has been set, the temperature display will return to the actual fresh food and freezer temperatures after 5 seconds. Several adjustments may be required. Each time you adjust controls, allow 24 hours for the refrigerator to reach the temperature you have set.

**To turn the cooling system off,** tap the  (warmer) pad for either the fresh food compartment or the freezer until the display shows OFF. **To turn the unit back on,** press the  (colder) pad for either the fresh food compartment or freezer. The SET light will illuminate on the side you selected. Then press the  (colder) pad again (on the side where the SET light is illuminated) and it will go to the preset points of 0°F for the freezer and 37°F for the fresh food compartment.

### Performance Air Flow System

The Performance Air-Flow System is designed to maximize temperature control in the fresh food and freezer compartments. This unique special feature consists of the Air Tower along the top and back walls of the fresh food compartment and the Air Tunnel on the bottom portion of the freezer rear wall.

Placing food in front of the louvers on these components will not affect performance.

Although the Air Tower and the Air Tunnel can be removed, doing so will affect temperature performance. (For removal instructions, on-line, 24 hours a day, contact us at [www.monogram.com](http://www.monogram.com) or call 800.444.1845. In Canada, call us at 1.800.561.3344.)



## How it works



**TurboCool** rapidly cools the refrigerator compartment in order to more quickly cool foods. Use **TurboCool** when adding a large amount of food to the refrigerator compartment, putting away foods after they have been sitting out at room temperature or when putting away warm leftovers. It can also be used if the refrigerator has been without power for an extended period.

Once activated, the compressor will turn on immediately and the fans will cycle on and off at high speed as needed for 8 hours. The compressor will continue to run until the refrigerator compartment cools to approximately 34°F (1°C), then it will cycle on and off to maintain this setting. After 8 hours, or if **TurboCool** is pressed again, the refrigerator compartment will return to the original setting.

---

## How to use

- 1 Press **TurboCool**. The refrigerator temperature display will show TC.
- 2 After **TurboCool** is complete, the refrigerator compartment will return to the original setting.

### NOTES:

- The refrigerator temperature cannot be changed during **TurboCool**.
- The freezer temperature is not affected during **TurboCool**.
- When opening the refrigerator door during **TurboCool**, the fans will continue to run if they have cycled on.

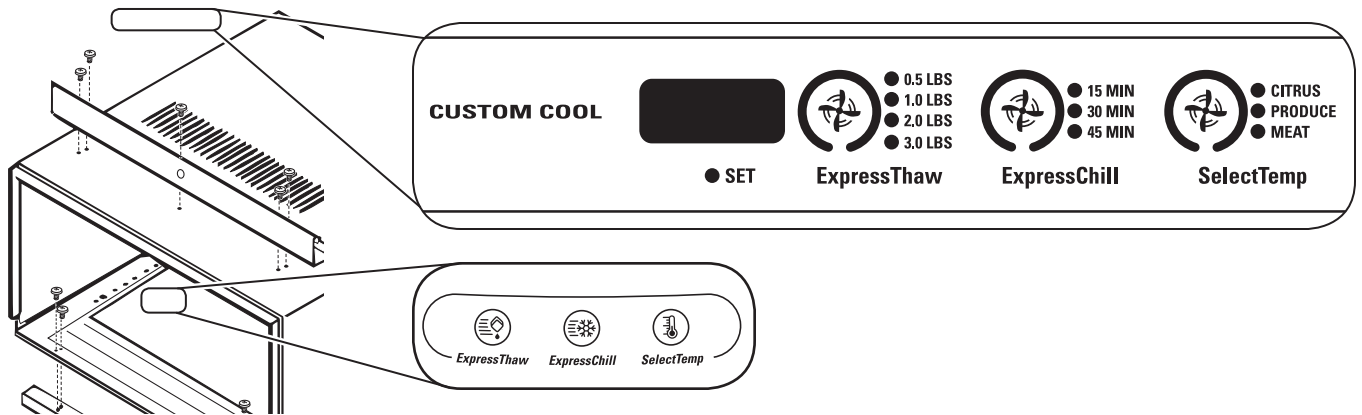

### How it works

The **CustomCool** feature is a system of dampers, a fan, a temperature thermistor and a heater. Depending on the function selected, a combination of these will be used to quickly chill items, thaw items or hold the pan at a specific temperature.

The pan is tightly sealed to prevent the pan's temperature from causing temperature fluctuations in the rest of the refrigerator.

The controls for this pan are located at the top of the fresh food compartment with the temperature controls.

### How to use

- 1 Empty the pan. Place the Chill/Thaw tray in the pan. Place the items on the tray and close the pan completely.
- 2 Select the **ExpressThaw™**, **ExpressChill™** or **SelectTemp™** pad. The display and SET light will come on. Tap the pad until the light appears next to the desired setting. Use the chart to determine the best setting to use.
  - To stop a feature before it is finished, tap that feature's pad until no options are selected and the display is off.
  - During **ExpressThaw** and **ExpressChill**, the display on the controls will count down the time in the cycle.
  - After the **ExpressThaw** cycle is complete, the pan will reset to the MEAT setting (31°F) to help preserve thawed items until they are used.
  - The displayed actual temperature of the **CustomCool** pan may vary slightly from the SET temperature based on usage and operating environment.

**NOTE:** For food safety reasons, it is recommended that foods be wrapped in plastic wrap when using **ExpressThaw**. This will help contain meat juices and improve thawing performance.

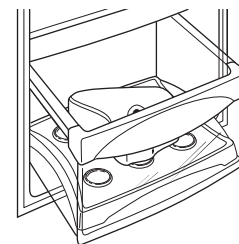

ExpressThaw™

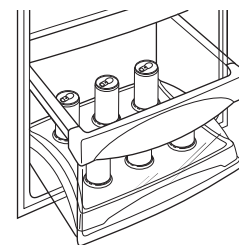

ExpressChill™

CustomCool™  
chart

**NOTE:** Results may vary depending on packaging, starting temperature and other food traits.



**0.5 Lb. (4 hours)**

- Hamburger Patties (0.5 lb)
- Individually Wrapped Filet Mignon (0.5 lb)

**1.0 Lb. (6 hours)**

- Chicken Breasts (1.0 lb)
- Ground Beef (1.0 lb)
- Steak (1.0 lb)

**2.0 Lbs. (10 hours)**

- Chicken Breasts (2.0 lbs)
- Ground Beef (2.0 lbs)
- Steak (2.0 lbs)

**3.0 Lbs. (12 hours)**

- Chicken Breasts (3.0 lbs)
- Ground Beef (3.0 lbs)
- Steak (3.0 lbs)

**15 Minutes**

- 1 Beverage Can (12 oz)
- 2 Small Juice Boxes (6–8 oz each)

**30 Minutes**

- 2 to 6 Beverage Cans (12 oz each)
- 2 Plastic 20 oz Bottles of Beverage

- 4 to 6 Small Juice Boxes (6–8 oz each)
- 3 Foil Juice Packets
- Wine (750 ml bottle)

**45 Minutes**

- 2 Liter of Beverage
- 1/2 Gallon of Juice
- Gelatin – 1 package

**Citrus Setting (43°F)**

- Oranges, Lemons, Limes, Pineapple, Cantaloupe
- Beans, Cucumbers, Tomatoes, Peppers, Eggplant, Squash

**Produce Setting (35°F)**

- Strawberries, Raspberries, Kiwifruit, Pears, Cherries, Blackberries, Grapes, Plums, Nectarines, Apples
- Asparagus, Broccoli, Corn, Mushrooms, Spinach, Cauliflower, Kale, Green Onion, Beets, Onions

**Meat Setting (31°F)**

- Raw Meat, Fish and Poultry

*How to remove and replace the drawer*

**To remove:**

- 1 Pull the drawer out to the stop position.
- 2 Lift the front of the drawer up and out of the wire holder.
- 3 Lift the back of the drawer up and out.

**To replace:**

- 1 Place the back of the drawer in the wire holder, making sure the wire holder fits into the grooves on the back of the pan.
- 2 Lower the front of the drawer into the wire holder.
- 3 Pull the bottom of the wire holder forward until the wire pops into the groove located on the bottom of the drawer.

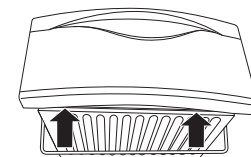
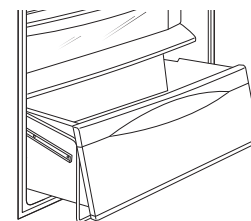

Pop wire into groove

### Water filter cartridge

#### Water filter cartridge

The water filter cartridge is located in the back upper right corner of the refrigerator compartment.

#### When to replace the filter on models with a replacement indicator light

There is a replacement indicator light for the water filter cartridge on the dispenser. This light will turn orange to tell you that you need to replace the filter soon.

The filter cartridge should be replaced when the replacement indicator light turns red or if the flow of water to the dispenser or icemaker decreases.

#### When to replace the filter on models without a replacement indicator light

The filter cartridge should be replaced every **six months** or earlier if the flow of water to the dispenser or icemaker decreases.

#### Removing the filter cartridge

If you are replacing the cartridge, first remove the old one by slowly turning it to the left. **Do not** pull down on the cartridge. A small amount of water may drip down.

**CAUTION:** To reduce the risk associated with property damage due to water leakage, read and follow instructions before installation and use of this system. Installation and use **MUST** comply with all state and local plumbing codes.

#### Installing the filter cartridge

- 1** Fill the replacement cartridge with water from the tap to allow for better flow from the dispenser immediately after installation.
- 2** Line up the arrow on the cartridge and the cartridge holder. Place the top of the new cartridge up inside the holder. **Do not** push it up into the holder.
- 3** Slowly turn it to the right until the filter cartridge stops. **DO NOT OVERTIGHTEN.** As you turn the cartridge, it will automatically raise itself into position. The cartridge will move about a ½ turn.
- 4** Run water from the dispenser for 1-1/2 gallons (about three minutes) to clear the system and prevent sputtering.
- 5** Press and hold the RESET WATER FILTER pad (on some models) on the dispenser for three seconds.

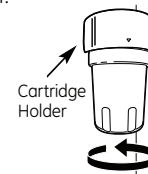

**NOTE:** A newly installed water filter cartridge may cause water to spurt from the dispenser.

#### Filter bypass plug

You must use the filter bypass plug when a replacement filter cartridge is not available. The dispenser and the icemaker will not operate without the filter or filter bypass plug.

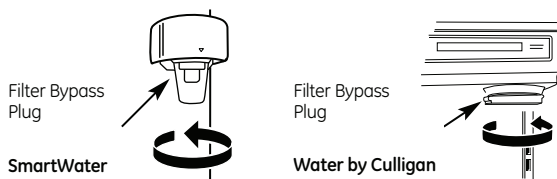

To use the filter bypass plug on Water by Culligan™ models, you must first remove the filter adaptor from the cartridge holder by turning it to the left.

### **WARNING**

**To reduce the risk associated with choking, do not allow children under 3 years of age to have access to small parts during the installation of this product.** The disposable filter cartridge should be replaced every 6 months at the rated capacity, or sooner if a noticeable reduction in flow rate occurs.

For the maximum benefit of your filtration system, GE recommends the use of GE-branded filters only. Using GE-branded filters in GE and Hotpoint® refrigerators provides optimal performance and reliability. GE filters meet rigorous industry NSF standards for safety and quality that are important for products that are filtering your water. GE has not qualified non-GE-branded filters for use in GE and Hotpoint refrigerators and there is no assurance that non-GE-branded filters meet GE's standards for quality, performance and reliability.

**If you have questions, or to order additional filter cartridges, visit our website at [www.gewaterfilters.com](http://www.gewaterfilters.com) or call GE Parts and Accessories, 800.626.2002.**

Customers in Canada should consult the yellow pages for the nearest Camco Service Center.

### Fresh food compartment door bins and freezer door tilt-out bins

#### Large Bins

The larger fresh food compartment door bins and freezer tilt-out door bins are adjustable.

**To remove:** Lift the front of the bin straight up, then lift up and out.

**To replace or relocate:** Engage the back side of the bin in the molded supports of the door. Then push down on the front of the bin. Bin will lock in place.

#### Small Bins

**To remove:** Lift the front of the bin straight up, then out.

**To replace:** Position the bin above the rectangular molded supports on the door. Then slide the bin down onto the support to lock it in place.

**The snigger** helps prevent tipping, spilling or sliding of small items stored on the door shelf. Place a finger on either side of the snigger near the rear and move it back and forth to fit your needs.

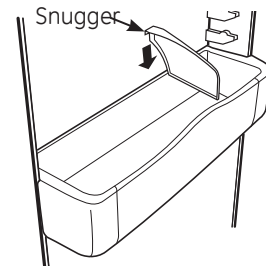

Fresh food compartment door bin

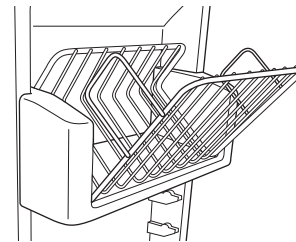

Freezer tilt-out bin

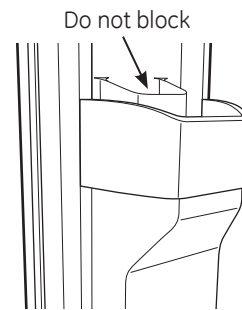

Top freezer bin

**CAUTION:** Be careful when placing items in the top bin. Make sure that items do not block or fall into the ice chute.

**MISE EN GARDE :** Soyez prudents lorsque vous placez des articles dans le bac supérieur. Assurez-vous qu'aucun objet ne bloque ou tombe dans la chute à glaçons.

### Slide-out spillproof shelf

The slide-out spillproof shelf allows you to reach items stored behind others. The special edges are designed to help prevent spills from dripping to lower shelves.

**To remove:** Slide the shelf out until it reaches the stop, then press down on the tab and slide the shelf straight out.

**To replace or relocate:** Line the shelf up with the supports and slide it into place. The shelf can be repositioned when the door is at 90° or more. To reposition the shelf, slide the shelf past the stops and angle downward. Slide shelf down to the desired position, line up with the supports and slide into place.

**NOTE:** Make sure you push the shelves all the way back in before you close the door.

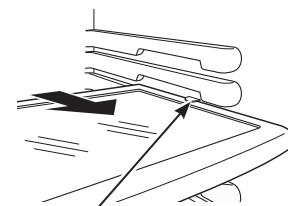

Press tab and pull shelf forward to remove

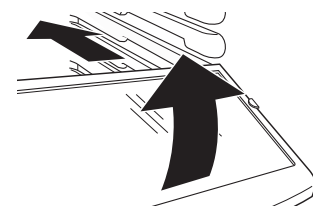

## Shelves and Bins

Stainless Steel Refrigerator

### QuickSpace™ shelf

This shelf splits in half and slides under itself for storage of tall items on the shelf below.

This shelf can be removed and replaced or relocated just like Slide-Out Spillproof Shelves.

On some models, this shelf can not be used in the lowest position.

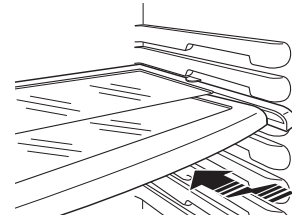

### Freezer baskets

**To remove,** push the basket all the way to the back of the freezer. Lift up until the back pins are disengaged. Lift the entire basket up and pull out.

**NOTE:** Make sure you push the baskets all the way back in before you close the door.

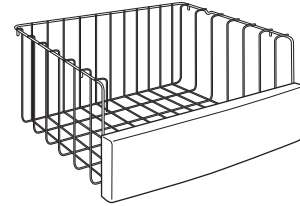

### Slide-out freezer shelves

**To remove,** slide out to the **stop** position, lift the front past the stop position, and slide out.

**NOTE:** Make sure you push the shelves all the way back in before you close the door.

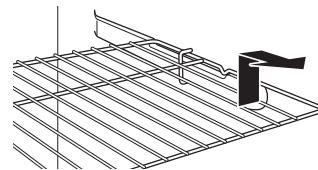

### Fixed freezer shelves

**To remove,** lift the shelf up at the left side and then bring the shelf out.

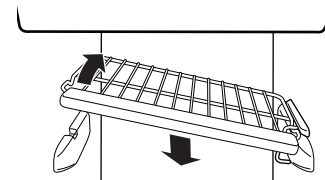

### Door wine/ beverage rack

This rack holds up to 5 cans, one bottle of wine or one 2-liter bottle of soda.

The rack hangs from the sides of the dairy bin.

**To remove:**

- 1 Empty the wine/beverage rack.
- 2 Holding the bottom of the dairy bin, lift the front straight up, then lift up and out.
- 3 To detach the rack from the dairy bin, pull the rack's side wires out of the holes on each side of the dairy bin.

**To replace:**

- 1 Reattach the rack to the sides of the bin.
- 2 Engage the back side of the bin in the molded supports on the door. Then push down on the front of the bin. The bin will lock into place.

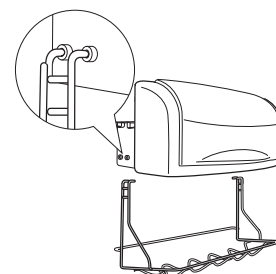
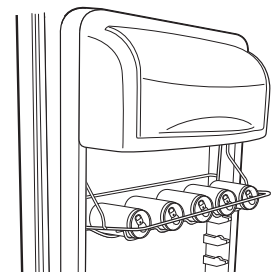

#### Refrigerator doors

The refrigerator doors may feel different than the ones you are used to. The special door opening/closing feature makes sure the doors close all the way and are securely sealed.

When opening and closing the door you will notice a **stop** position. If the door is opened past this **stop** point, the door will remain open to allow you to load and unload food more easily. When the door is only partially open, it will automatically close.

The resistance you feel at the **stop** position will be reduced as the door is loaded with food.

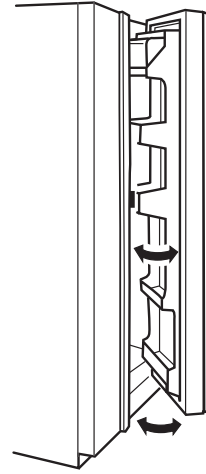

When the door is only partially open, it will automatically close. Beyond this **stop** the door will stay open.

#### Door alignment

If doors are uneven, adjust the refrigerator door.

- 1 Using a 7/16" socket wrench, turn the door adjusting screw to the right to raise the door, to the left to lower it. (A nylon plug, imbedded in the threads of the pin, prevents the pin from turning unless a wrench is used.)
- 2 After one or two turns of the wrench, open and close the refrigerator door and check the alignment at the top of the doors.

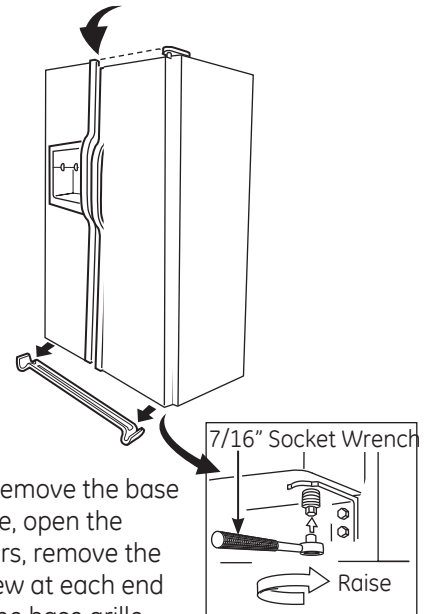

To remove the base grille, open the doors, remove the screw at each end of the base grille and then pull the grille straight out.

## Crispers and Pans

Stainless Steel Refrigerator

### Fruit and vegetable crispers

Excess water that may accumulate in the bottom of the drawers should be wiped dry.

The bottom drawer has a cover that slides back as the drawer is opened. This allows full access to the drawer. As the drawer is closed, the cover will slide forward into its original position.



### Adjustable humidity crispers

Slide the control all the way to the **HI** setting to provide high humidity recommended for most vegetables.

Slide the control all the way to the **LO** setting to provide lower humidity levels recommended for most fruits.

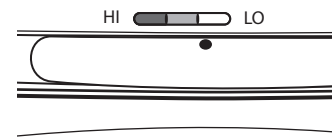

### Convertible meat pan

The convertible meat pan has its own cold air duct to allow a stream of cold air from the freezer compartment to flow to the pan.

**The variable temperature control** regulates the air flow from the Climate Keeper.

Set the control to the **coldest** setting to store fresh meats.

Set the control to cold to convert the pan to normal refrigerator temperature and provide extra vegetable storage space. The **cold** air duct is turned off. Variable settings between these extremes can be selected.

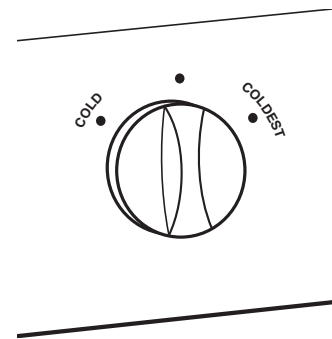

### Crisper removal

Crispers can easily be removed by pulling the drawer straight out and lifting the drawer up and over the **stop** location.

If the door prevents you from taking out the drawers, first try to remove the door bins. If this does not offer enough clearance, the refrigerator will need to be rolled forward until the door opens enough to slide the drawers out. In some cases, when you roll the refrigerator out, you will need to move the refrigerator to the left or right as you roll it out.

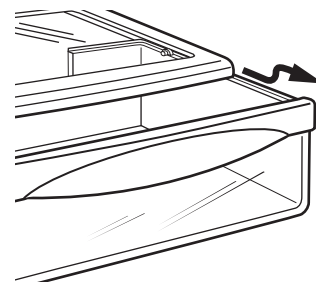



Automatic  
icemaker

**NOTE:** A newly installed refrigerator may take 12 to 24 hours to begin making ice.

The icemaker will produce seven cubes per cycle—approximately 100–130 cubes in a 24-hour period, depending on freezer compartment temperature, room temperature, number of door openings and other use conditions.

If the refrigerator is operated before the water connection is made to the icemaker, set the power switch in the **OFF** position.

When the refrigerator has been connected to the water supply, set the power switch to the **ON** position.

The icemaker will fill with water when it cools to 15°F (–10°C). A newly installed refrigerator may take 12 to 24 hours to begin making ice cubes.

You will hear a buzzing sound each time the icemaker fills with water.

Throw away the first few batches of ice to allow the water line to clear.

Be sure nothing interferes with the sweep of the feeler arm.

When the bin fills to the level of the feeler arm, the icemaker will stop producing ice. It is normal for several cubes to be joined together.

If ice is not used frequently, old ice cubes will become cloudy, taste stale and shrink.

**Special notes:**

- Dispenser models have a tilt-out ice bin. The bin can be tilted out as shown in the illustrations, and it will hold itself up while you take ice out or turn the icemaker power switch on and off. Be sure to put the bin back in place before closing the door.
- **To restore your ice level from an empty bucket stage, the following steps are recommended:**
  - 1** 12 hours after the first batch of ice has fallen into the bin, dispense 3 to 4 cubes.
  - 2** After an additional 6 hours, dispense 3 to 4 cubes again.

These steps will restore your ice level in the shortest amount of time.

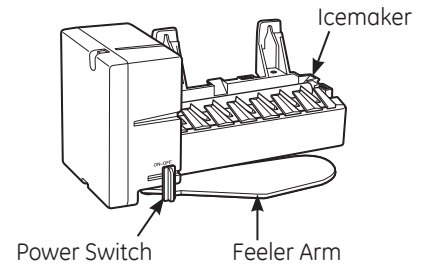
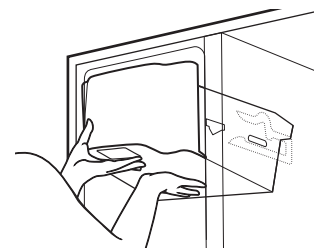
**To access ice or reach the power switch:**

- 1** Lift the bin, then pull it forward until the bin stops.

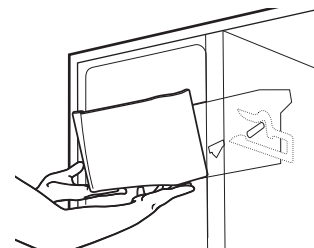

- 2** Lower the bin to access ice or reach the power switch.

**NOTE:** In order to take full advantage of the tilt-out ice bin, only store items on the shelf below the ice bin that are no taller than the lowest point on the bin.

Removing  
ice bin

**⚠ CAUTION:** *The ice bin is heavy when full.*

**⚠ MISE EN GARDE :** *La glace pèse lourd quand le tiroir est plein.*

Set the power switch to the **OFF** position before removing the bin.

**When replacing the bin**, be sure to press it firmly into place. If it does not go all the way back, remove it and rotate the drive mechanism 1/4 turn. Then push the bin back again.

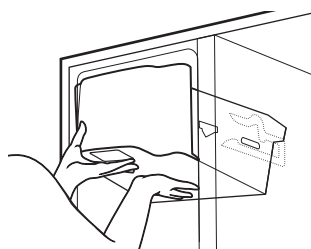
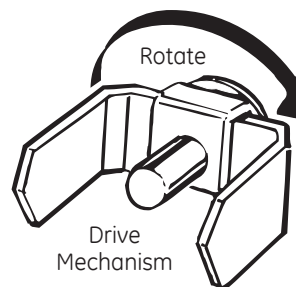

**1** Lift the bin, then pull it forward until the bin stops.

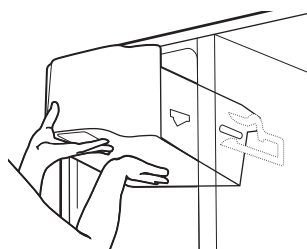

**2** Lift and pull forward again to remove the bin.

## Using the dispenser

Select CUBED ICE , CRUSHED ICE  or WATER .

Press the glass gently against the top of the dispenser cradle.

The spill shelf is not self-draining. To reduce water spotting, the shelf and its grille should be cleaned regularly.

**NOTE:** If no water is dispensed when the refrigerator is first installed, there may be air in the water line system. Press the dispenser arm for at least 2 minutes to remove trapped air from the water line and to fill the water system. To flush out impurities in the water line, throw away the first 6 glassfuls of water.

**CAUTION:** Never put fingers or any other objects into the ice crusher discharge opening.

**ATTENTION :** Ne mettez jamais les doigts ou d'autres objets dans l'ouverture du distributeur.



## Other dispenser controls

### Locking the Dispenser



Press the CONTROL LOCK pad for 3 seconds to lock the dispenser and control panel. To unlock, press and hold the pad again for 3 seconds.

### Quick Ice



When you need ice in a hurry, press this pad to speed up ice production. This will increase ice production for the following 48 hours or until you press the pad again.

### Dispenser Light



This pad turns the **night light** in the dispenser on and off. The light also comes on when the dispenser cradle is pressed. For models with a bulb, if the light burns out, it should be replaced with a 6 watt 12V maximum bulb. For LED models, contact Factory Service".

### Door Alarm



To set the alarm, press this pad until the indicator light comes on. This alarm will sound if either door is open for more than 3 minutes. The light goes out and the beeping stops when you close the door.

## Important facts about the dispenser

- Do not add ice from trays or bags to the storage drawer. It may not crush or dispense well.
- Avoid overfilling glass with ice and use of narrow glasses. Backed-up ice can jam the chute or cause the door in the chute to freeze shut. If ice is blocking the chute, poke it through with a wooden spoon.
- Beverages and foods should not be quick-chilled in the ice storage drawer. Cans, bottles or food packages in the storage drawer may cause the icemaker or auger to jam.
- To keep dispensed ice from missing the glass, put the glass close to, but not touching, the dispenser opening.
- Some crushed ice may be dispensed even though you selected CUBED ICE. This happens occasionally when a few cubes accidentally get directed to the crusher.
- After crushed ice is dispensed, some water may drip from the chute.
- Sometimes a small mound of snow will form on the door in the ice chute. This condition is normal and usually occurs when you have dispensed crushed ice repeatedly. The snow will eventually evaporate.

#### Cleaning the outside

##### **The dispenser drip**

area, beneath the grille, should be wiped dry. Water left in this area may leave deposits. Remove the deposits by adding undiluted vinegar to the well. Soak until the deposits disappear or become loose enough to rinse away.

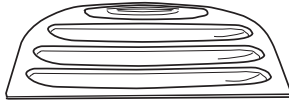

Dispenser drip area.

**The dispenser cradle.** Before cleaning, lock the dispenser by pressing and holding the CONTROL LOCK pad for 3 seconds. Clean with warm water and baking soda solution—about a tablespoon (15 ml) of baking soda to a quart (1 liter) of water. Rinse thoroughly and wipe dry.

**The stainless steel panels and handles** can be cleaned with a commercially available stainless steel cleaner such as *Stainless Steel Magic*.™

*Stainless Steel Magic* is available at Ace, True Value, Servistar, HWI and other leading stores. It is also available through GE Parts and Accessories, 800.626.2002. Order part number WX10X15.

**Do not use appliance wax or polish on the stainless steel.**

#### Cleaning the inside

**To help prevent odors,** leave an open box of baking soda in the fresh food and freezer compartments.

##### **Unplug the refrigerator before cleaning.**

If this is not practical, wring excess moisture out of sponge or cloth when cleaning around switches, lights or controls.

Use warm water and baking soda solution—about a tablespoon (15 ml) of baking soda to a quart (1 liter) of water. This both cleans and neutralizes odors. Rinse and wipe dry.

**Use of any cleaning solution other than that which is recommended, especially those that contain petroleum distillates, can crack or damage the interior of the refrigerator.**

**Avoid cleaning cold glass shelves with hot water because the extreme temperature difference may cause them to break. Handle glass shelves carefully. Bumping tempered glass can cause it to shatter.**

**Do not wash any plastic refrigerator parts in the dishwasher.**

**The Chill/Thaw tray is dishwasher safe.**

#### *Behind the refrigerator*

Be careful when moving the refrigerator away from the wall. All types of floor coverings can be damaged, particularly cushioned coverings and those with embossed surfaces.

Pull the refrigerator straight out and return it to position by pushing it straight in. Moving the refrigerator in a side direction may result in damage to the floor covering or refrigerator.

***When pushing the refrigerator back, make sure you don't roll over the power cord or icemaker supply line.***

---

#### *Preparing for vacation*

For long vacations or absences, remove food and unplug the refrigerator. Clean the interior with a baking soda solution of one tablespoon (15 ml) of baking soda to one quart (1 liter) of water. Leave the doors open.

Set the icemaker power switch to the **OFF** position and shut off the water supply to the refrigerator.

If the temperature can drop below freezing, have a qualified servicer drain the water supply system to prevent serious property damage due to flooding.

---

#### *Preparing to move*

Secure all loose items such as shelves and drawers by taping them securely in place to prevent damage.

When using a hand truck to move the refrigerator, do not rest the front or back of the refrigerator against the hand truck. This could damage the refrigerator. Handle only from the sides of the refrigerator.

***Be sure the refrigerator stays in an upright position during moving.***

## Replacing the Light Bulbs

*Stainless Steel Refrigerator*

### *Fresh food compartment— upper light*

**Setting the controls to OFF does not remove power to the light circuit.**

- 1 Unplug the refrigerator.
- 2 The bulbs are located at the top of the compartment, inside the light shield. On some models, a screw at the front of the light shield will have to be removed.
- 3 To remove the light shield, press in on the tabs on the sides of the shield and slide forward and out.

- 4 After replacing the bulb with an appliance bulb of the same or lower wattage, replace the light shield and screws (on some models). When replacing the light shield, make sure that the tabs at the back of the shield fit into the slots at the back of the light shield housing.
- 5 Plug the refrigerator back in.

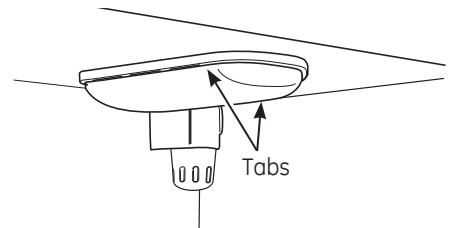

### *Fresh food compartment— lower light*

**Setting the controls to OFF does not remove power to the light circuit.**

**This light is located above the top pan.**

- 1 Unplug the refrigerator.
- 2 Remove the convertible meat drawer control knob by pulling straight out.
- 3 Lift the light shield up and pull it out.
- 4 After replacing the bulb with an appliance bulb of the same or lower wattage, replace the shield and the knob.
- 5 Plug the refrigerator back in.

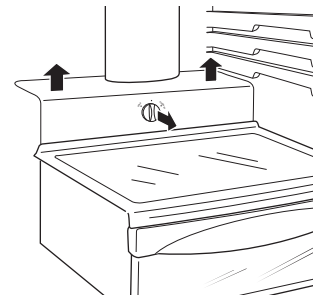

### *Freezer compartment*

**Setting the controls to OFF does not remove power to the light circuit.**

- 1 Unplug the refrigerator.
- 2 Remove the shelf just above the light shield. (The shelf will be easier to remove if it is emptied first.) On some models, a screw at the top of the light shield will need to be removed.
- 3 To remove the light shield, press in on the sides, and lift up and out.

- 4 Replace the bulb with an appliance bulb of the same or lower wattage, and reinstall the light shield. When reinstalling the light shield, make sure the top tabs snap securely into place. Replace the screw (on some models).
- 5 Reinstall the shelf and plug the refrigerator back in.

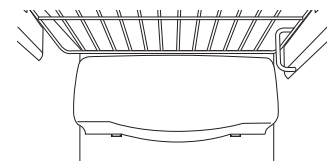

### *Dispenser*

**Setting the controls to OFF does not remove power to the light circuit.**

- 1 Unplug the refrigerator.
- 2 The bulb is located on the dispenser under the control panel. Remove the light bulb by turning it counterclockwise.

- 3 Replace the bulb with a bulb of the same size and wattage.
- 4 Plug the refrigerator back in.

Normal operating sounds

Newer refrigerators sound different from older refrigerators. Modern refrigerators have more features and use newer technology.

**Do you hear what I hear? These sounds are normal.**

**HUMMM...  
WHOOSH...**

- The new high efficiency compressor may run faster and longer than your old refrigerator and you may hear a high-pitched hum or pulsating sound while it is operating.
- Sometimes the refrigerator runs for an extended period, especially when the doors are opened frequently. This means that the **Frost Guard™** feature is working to prevent freezer burn and improve food preservation.
- You may hear a whooshing sound when the doors close. This is due to pressure equalizing within the refrigerator.



- You may hear the fans spinning at high speeds. This happens when the refrigerator is first plugged in, when the doors are opened frequently or when a large amount of food is added to the refrigerator or freezer compartments. The fans are helping to maintain the correct temperatures.
- If either door is open for over 3 minutes, you may hear the fans come on in order to cool the light bulbs.
- The fans change speeds in order to provide optimal cooling and energy savings.
- You may hear the fans running after selecting one of the **CustomCool™** settings.

**CLICKS, POPS,  
CRACKS and CHIRPS**

- You may hear cracking or popping sounds when the refrigerator is first plugged in. This happens as the refrigerator cools to the correct temperature.
- Electronic dampers click open and closed to provide optimal cooling and energy savings.
- The compressor may cause a clicking or chirping sound when attempting to restart (this could take up to 5 minutes).
- The electronic control board may cause a clicking sound when relays activate to control refrigerator components.
- Expansion and contraction of cooling coils during and after defrost can cause a cracking or popping sound.
- After an icemaking cycle, you may hear the ice cubes dropping into the ice bucket.

**WATER SOUNDS**



- The flow of refrigerant through the freezer cooling coils may make a gurgling noise like boiling water.
- Water dropping on the defrost heater can cause a sizzling, popping or buzzing sound during the defrost cycle.
- A water dripping noise may occur during the defrost cycle as ice melts from the evaporator and flows into the drain pan.
- Closing the door may cause a gurgling sound due to pressure equalization.



For additional information on normal icemaker and dispenser operating sounds, see the Automatic Icemaker and Ice and Water Dispenser sections.

Questions?  
Use this  
problem  
solver!

<b>PROBLEM</b>	<b>POSSIBLE CAUSE</b>
<b>REFRIGERATOR DOES NOT OPERATE</b>	<ul style="list-style-type: none"> <li>• Refrigerator may be in defrost cycle when motor does not operate for about 30 minutes.</li> <li>• Either or both controls set to OFF. Set to a temperature setting.</li> <li>• If interior light is not on, refrigerator may not be plugged in at wall outlet. Push the plug completely into the wall outlet.</li> <li>• The fuse is blown/circuit breaker is tripped. Replace fuse or reset the breaker.</li> <li>• The refrigerator is in showroom mode. Unplug it and plug it back in.</li> </ul>
<b>VIBRATION OR RATTLING (Slight vibration is normal.)</b>	<ul style="list-style-type: none"> <li>• Adjust the rollers as shown in the Installation Instructions.</li> </ul>
<b>MOTOR OPERATES FOR LONG PERIODS OR CYCLES ON AND OFF FREQUENTLY (Modern refrigerators with more storage space and a larger freezer require more operating time. They start and stop often to maintain even temperatures.)</b>	<ul style="list-style-type: none"> <li>• Normal when refrigerator is first plugged in. Wait 24 hours for the refrigerator to completely cool down.</li> <li>• Often occurs when large amounts of food are placed in refrigerator. This is normal.</li> <li>• Door left open or package holding door open.</li> <li>• Hot weather or frequent door openings. This is normal.</li> <li>• Temperature controls set at the coldest setting. See Temperature Controls.</li> </ul>
<b>FRESH FOOD OR FREEZER COMPARTMENT TOO WARM</b>	<ul style="list-style-type: none"> <li>• Temperature controls not set cold enough. See Temperature Controls.</li> <li>• Warm weather or frequent door openings.</li> <li>• Door left open for long time.</li> <li>• Package may be holding door open.</li> </ul>
<b>FROST OR ICE CRYSTALS ON FROZEN FOOD (Frost within package is normal.)</b>	<ul style="list-style-type: none"> <li>• Door left open or package holding door open.</li> <li>• Too frequent or too long door openings.</li> </ul>
<b>DIVIDER BETWEEN FRESH FOOD AND FREEZER COMPARTMENTS FEELS WARM</b>	<ul style="list-style-type: none"> <li>• Automatic energy saver system circulates warm liquid around the front edge of the freezer compartment to help prevent condensation from forming on the outside.</li> </ul>
<b>AUTOMATIC ICEMAKER DOES NOT WORK</b>	<ul style="list-style-type: none"> <li>• Icemaker power switch is in the <b>OFF</b> position.</li> <li>• Water supply turned off or not connected. See Installation Instructions.</li> <li>• Freezer compartment too warm. Allow 24 hours for the refrigerator to completely cool down.</li> <li>• Piled up cubes in storage bin cause icemaker to shut off. Level cubes in bin.</li> <li>• Ice cubes stuck in icemaker. Turn off the icemaker, remove cubes and turn the icemaker back on.</li> </ul>



Questions?  
Use this  
problem  
solver!

<b>PROBLEM</b>	<b>POSSIBLE CAUSE</b>
<b>FREQUENT "BUZZING" SOUND</b>	<ul style="list-style-type: none"> <li>• Icemaker power switch is in the <b>ON</b> position, but the water supply to the refrigerator has not been connected. Set the power switch to the <b>OFF</b> position. Keeping it in the <b>ON</b> position will damage the water valve.</li> </ul>
<b>ICE CUBES HAVE ODOR/TASTE</b>	<ul style="list-style-type: none"> <li>• Old cubes need to be discarded.</li> <li>• Ice storage bin needs to be emptied and washed.</li> <li>• Unsealed packages in fresh food and/or freezer compartments may be transmitting odor/taste to ice cubes.</li> <li>• Interior of refrigerator needs cleaning. See Care and Cleaning.</li> </ul>
<b>SMALL OR HOLLOW CUBES</b>	<ul style="list-style-type: none"> <li>• Water filter clogged. Replace the filter or use the filter bypass plug.</li> </ul>
<b>SLOW ICE CUBE FREEZING</b>	<ul style="list-style-type: none"> <li>• Door may have been left open.</li> <li>• Turn temperature of freezer compartment colder. See Temperature Controls.</li> </ul>
<b>CUBE DISPENSER DOES NOT WORK</b>	<ul style="list-style-type: none"> <li>• Icemaker or water supply turned off. Turn on icemaker or water supply.</li> <li>• Ice cubes are frozen to the icemaker feeler arm. Remove the cubes.</li> <li>• Irregular clumps in the storage bin. Break up with fingertip pressure and discard remaining clumps. The freezer may be too warm. Adjust the freezer temperature control colder one step at a time until clumps do not form.</li> <li>• The dispenser is LOCKED. Press and hold the CONTROL LOCK pad for 3 seconds.</li> <li>• An item is blocking or has fallen into the ice chute inside the top door bin of the freezer. Remove any item that might be blocking or has fallen into the chute.</li> </ul>
<b>WATER HAS POOR TASTE/ODOR</b>	<ul style="list-style-type: none"> <li>• Water dispenser has not been used for a long time. Dispense water until all water in the system has been replenished.</li> </ul>
<b>WATER IN FIRST GLASS IS WARM</b>	<ul style="list-style-type: none"> <li>• Normal when refrigerator is first installed. Allow 24 hours for the refrigerator to completely cool down.</li> <li>• Water dispenser has not been used for a long time. Dispense water until all water in the system has been replenished.</li> <li>• Water system has been drained. Allow several hours for the replenished water supply to chill.</li> </ul>
<b>WATER DISPENSER DOES NOT WORK</b>	<ul style="list-style-type: none"> <li>• Water supply line turned off or not connected. See the Installation Instructions.</li> <li>• Water filter clogged. Replace the filter or use the filter bypass plug.</li> <li>• Air may be trapped in the system. Press the dispenser arm for at least 2 minutes.</li> <li>• The dispenser is LOCKED. Press and hold the CONTROL LOCK pad for 3 seconds.</li> </ul>
<b>WATER SPURTING FROM DISPENSER</b>	<ul style="list-style-type: none"> <li>• Newly installed filter cartridge. Run water from the dispenser for about 3 minutes (about 1½ gallons).</li> </ul>

## The Problem Solver

*Stainless Steel Refrigerator*

Questions?  
Use this  
problem  
solver!

<b>PROBLEM</b>	<b>POSSIBLE CAUSE</b>
<b>WATER IS NOT DISPENSED BUT ICEMAKER IS WORKING</b>	<ul style="list-style-type: none"> <li>• Water in reservoir is frozen. Call for service.</li> <li>• Fresh food control setting is too cold. Set to a warmer setting.</li> </ul>
<b>NO WATER OR ICE CUBE PRODUCTION</b>	<ul style="list-style-type: none"> <li>• Water supply line or shutoff valve is clogged. Call a plumber.</li> <li>• Replace the filter or use the filter bypass plug.</li> <li>• The dispenser is LOCKED. Press and hold the CONTROL LOCK pad for 3 seconds.</li> </ul>
<b>CUBED ICE WAS SELECTED BUT CRUSHED ICE WAS DISPENSED</b>	<ul style="list-style-type: none"> <li>• The last setting was CRUSHED ICE and a few cubes were left in the crusher from the previous setting. This is normal.</li> </ul>
<b>ORANGE GLOW IN FREEZER</b>	<ul style="list-style-type: none"> <li>• Defrost heater is on. This is normal.</li> </ul>
<b>REFRIGERATOR HAS ODOR</b>	<ul style="list-style-type: none"> <li>• Foods with strong odors should be tightly wrapped.</li> <li>• Interior needs cleaning. See Care and Cleaning.</li> <li>• Keep open box of baking soda in refrigerator; replace every 3 months.</li> </ul>
<b>DOOR NOT CLOSING PROPERLY</b>	<ul style="list-style-type: none"> <li>• Door gasket on hinge side is sticking or folding over. Apply paraffin wax to the face of the gasket.</li> <li>• A door bin is hitting a shelf inside the refrigerator. Move the door bin up one position.</li> </ul>
<b>MOISTURE FORMS ON OUTSIDE OF REFRIGERATOR</b>	<ul style="list-style-type: none"> <li>• Not unusual during periods of high humidity. Wipe surface dry.</li> <li>• Door left open or package holding door open.</li> </ul>
<b>MOISTURE COLLECTS INSIDE</b>	<ul style="list-style-type: none"> <li>• Too frequent or too long door openings.</li> <li>• In humid weather, air carries moisture into refrigerator when doors are opened.</li> </ul>
<b>INTERIOR LIGHT DOES NOT WORK</b>	<ul style="list-style-type: none"> <li>• No power at outlet.</li> <li>• Light bulb needs replacing. See Care and Cleaning.</li> </ul>
<b>WATER ON KITCHEN FLOOR OR BOTTOM OF FREEZER</b>	<ul style="list-style-type: none"> <li>• Ice cubes jammed in chute. Poke ice through with a wooden spoon.</li> </ul>
<b>HOT AIR FROM BOTTOM OF REFRIGERATOR</b>	<ul style="list-style-type: none"> <li>• Normal air flow cooling motor. In the refrigeration process, it is normal that heat be expelled in the area under the refrigerator. Some floor coverings are sensitive and will discolor at these safe and normal temperatures.</li> </ul>
<b>REFRIGERATOR NEVER SHUTS OFF BUT TEMPERATURES ARE OK</b>	<ul style="list-style-type: none"> <li>• Adaptive defrost keeps compressor running during door openings. This is normal. The refrigerator will cycle off after the door remains closed for two hours.</li> </ul>
<b>REFRIGERATOR BEEPING</b>	<ul style="list-style-type: none"> <li>• Door is open and DOOR ALARM is on.</li> </ul>

Questions?  
Use this  
problem  
solver!

<b>PROBLEM</b>	<b>POSSIBLE CAUSE</b>
<b>FOOD ISN'T THAWING/CHILLING</b>	<ul style="list-style-type: none"> <li>• Packaging insulating food. Increase time or re-package in plastic.</li> <li>• The wrong weight is selected. Select a larger weight.</li> <li>• Item with high fat content. Select a larger weight.</li> <li>• Not using Chill/Thaw tray. Place items on tray and allow space in between items for better air flow.</li> </ul>
<b>ACTUAL TEMPERATURE NOT EQUAL TO SET TEMPERATURE</b>	<ul style="list-style-type: none"> <li>• Unit just plugged in. Allow 24 hours for the system to stabilize.</li> <li>• Door open for too long. Allow 24 hours for the system to stabilize.</li> <li>• Warm food added to refrigerator. Allow 24 hours for the system to stabilize.</li> <li>• Defrost cycle is in process. Allow 24 hours for the system to stabilize.</li> </ul>
<b>SELECTTEMP FEATURE IS NOT WORKING</b>	<ul style="list-style-type: none"> <li>• Fresh food compartment temperature control is set at the warmest setting. This is normal. In order to minimize energy usage, the SELECTTEMP feature is disabled when the fresh food compartment temperature control is set at the warmest setting.</li> </ul>
<b>DOORS ARE NOT ALIGNED</b>	<ul style="list-style-type: none"> <li>• Unlevel floor. Adjust rollers then align doors by adjusting the fresh food compartment hinge. See Installation Instructions.</li> </ul>

# Performance Data Sheet

## SmartWater™ Filtration System—GE MWF Cartridge

The concentration of the indicated substances in water entering the system was reduced to a concentration less than or equal to the permissible limit for water leaving the system as specified in NSF/ANSI Standard 42 and Standard 53. System tested and certified by NSF International against NSF/ANSI Standard 42 and Standard 53 for the reduction of substances listed below.

### Capacity 300 Gallons (1,135 Liters). Contaminant Reduction Determined by NSF testing.

Substance Tested for Reduction	Average Influent	NSF specified Challenge Concentration	Avg % Reduction	Average Product Water Concentration	Max Permissible Product Water Concentration	NSF Reduction Requirements	NSF Test Report
Chlorine Taste and Odor	2.0 mg/L	2.0 mg/L ± 10%	97.5%	0.05 mg/L	N/A	≥ 50%	J-00077703
Nominal Particulate Class I, ≥0.5 to < 1.0 µm	7,833,333 pts/mL	At least 10,000 particles/mL	99.7%	18,617 pts/mL	N/A	≥85%	J-00077704
Cyst*	101,000 cysts/L	Minimum 50,000 cysts/L	99.99%	1 cyst/L	N/A	≥99.95%	J-00100036
Asbestos	47 MF/L	107 to 108 fibers/L; fibers greater than 10 µm in length	>99%	<1 MF/L	N/A	≥99%	J-00077707
Atrazine	0.009 mg/L	0.009 mg/L ± 10%	94.5%	0.0005 mg/L	0.003 mg/L	N/A	J-00077708
Benzene	0.016 mg/L	0.015 mg/L ± 10%±	96.7%	0.0005 mg/L	0.005 mg/L	N/A	J-00077717
Carbofuran	0.08 mg/L	0.08 mg/L ± 10%	98.7%	0.001 mg/L	0.04 mg/L	N/A	J-00077718
Endrin	0.007 mg/L	0.006 mg/L ± 10%	97.1%	0.0002 mg/L	0.002 mg/L	N/A	J-00100039
Lead @ pH 6.5	0.152 mg/L	0.15 mg/L ± 10%	99.3%	0.001 mg/L	0.010 mg/L	N/A	J-00077722
Lead @ pH 8.5	0.148 mg/L	0.15 mg/L ± 10%	99.3%	0.001 mg/L	0.010 mg/L	N/A	J-00077723
Lindane	0.002 mg/L	0.002 mg/L ± 10%	99.0%	0.00002 mg/L	0.0002 mg/L	N/A	J-00077726
Mercury @ pH 6.5	0.0058 mg/L	0.006 mg/L ± 10%	93.2%	0.0004 mg/L	0.002 mg/L	N/A	J-00100037
Mercury @ pH 8.5	0.0061 mg/L	0.006 mg/L ± 10%	93.2%	0.0004 mg/L	0.002 mg/L	N/A	J-00092355
P-Dichlorobenzene	0.222 mg/L	0.225 mg/L ± 10%	99.8%	0.005 mg/L	0.075 mg/L	N/A	J-00077729
Tetrachloroethylene	0.015 mg/L	0.015 mg/L ± 10%	96.7%	0.0005 mg/L	0.005 mg/L	N/A	J-00082184
Toxaphene	0.015 mg/L	0.015 mg/L ± 10%	93.2%	0.001 mg/L	0.003 mg/L	N/A	J-00077730
2,4-D	0.218 mg/L	0.210 mg/L ± 10%	99.5%	0.0009 mg/L	0.07 mg/L	N/A	J-00085470

\*Based on the use of Cryptosporidium parvum oocysts.

The following pharmaceutical reduction claims have not been certified by NSF International or the state of California. Claims tested and verified by independent laboratory:

Contaminant Reduction	Average Influent	NSF specified Challenge Concentration	Avg % Reduction	Average Product Water Concentration	Max Permissible Product Water Concentration	NSF Reduction Requirements	NSF Test Report
Atenolol	978 ng/L	N/A	99.5%	5.0 ng/L	N/A	N/A	J-00121587
Fluoxetine	907 ng/l	N/A	99.4%	5.4 ng/L	N/A	N/A	J-00121587
Ibuprofen	885 ng/L	N/A	94.1%	52.3 ng/L	N/A	N/A	J-00121588
Progesterone	1097 ng/L	N/A	99.5%	5.0 ng/L	N/A	N/A	J-00121589
Trimethoprim	415 ng/L	N/A	99.5%	2.0 ng/L	N/A	N/A	J-00121587

### Application Guidelines/Water Supply Parameters

Service Flow	0.5 gpm (21.9 lpm)	Water Pressure	40-120 psi (2.8-8.2 bar)
Water Supply	Potable Water	Water Temperature	33°F-100°F (0.6°C-38°C)

It is essential that the manufacturer's recommended installation, maintenance and filter replacement requirements be carried out for the product to perform as advertised. See Installation Manual for Warranty information.

**Note:** While the testing was performed under standard laboratory conditions, actual performance may vary.

Replacement Cartridge: MWF. For estimated costs of replacement elements please call 1-800-626-2002 or visit our website at [www.geapplianceparts.com](http://www.geapplianceparts.com).

### ⚠ WARNING

To reduce the risk associated with ingestion of contaminants:

- Do not use with water that is microbiologically unsafe or of unknown quality without adequate disinfection before and after the system. Systems certified for cyst reduction may be used on disinfected water that may contain filterable cysts. EPA Establishment Number 10350-MN-005.

For conditions of use, health claims certified by the California Department of Public Health, and replacements, see performance data sheet. California Department of Public Health Certification #05-1698. The contaminants or other substances removed or reduced by this water filter are not necessarily in all users' water.

### NOTICE

To reduce the risk associated with property damage due to water leakage:

- Read and follow use instructions before installation and use of this system.
- Installation and use **MUST** comply with all state and local plumbing codes.
- Do not install if water pressure exceeds 120 psi (8.2 bar). If your water pressure exceeds 80 psi, you **must** install a pressure-limiting valve. Contact a plumbing professional if you are uncertain how to check your water pressure.
- Do not install where water hammer conditions may occur. If water hammer conditions exist you **must** install a water hammer arrester. Contact a plumbing professional if you are uncertain how to check for this condition.
- Do not install on hot water supply lines. The maximum operating water temperature of this filter system is 100° F (38° C).
- Protect filter from freezing. Drain filter when temperatures drop below 33°F (0.6°C).
- The disposable filter cartridge **must** be replaced every 6 months at the rated capacity, or sooner if a noticeable reduction in flow rate occurs.



Tested and certified by NSF International against NSF/ANSI Standard 42 and Standard 53 in model GE MWF for the reduction of the claims specified on the performance data sheet.

State of California Department of Public Health  
**Water Treatment Device**  
**Certificate Number**  
**05-1698**

Date Issued: February 2, 2010  
Modified June 25, 2013

---

---

**Trademark/Model Designation**

GE MWF

**Replacement Elements**

MWF  
PLWF

**Manufacturer: General Electric Company**

---

---

The water treatment device(s) listed on this certificate have met the testing requirements pursuant to Section 116830 of the Health and Safety Code for the following health related contaminants:

**Microbiological Contaminants and Turbidity**

Cysts

**Inorganic/Radiological Contaminants**

Asbestos  
Lead  
Mercury

**Organic Contaminants**

Carbofuran  
Endrin  
p-Dichlorobenzene  
Benzene  
Atrazine  
Lindane  
Tetrachloroethylene  
Toxaphene  
2,4- D

---

**Rated Service Capacity 300 gallons**

**Rated Service Flow: 0.5 gallons per minute**

---

**Conditions of Certification**

Do not use where water is microbiologically unsafe or with water of unknown quality, except that systems for cyst reduction may be used on disinfected waters that contain filterable cysts.



**With the purchase of your new Monogram appliance, receive the assurance that if you ever need information or assistance from GE, we will be there. All you have to do is call—toll-free!**

**GE Answer Center®**

**In the USA:  
800.626.2000**

Whatever your question about any Monogram major appliance, GE Answer Center® information service is available to help. Your call—and your question—will be answered promptly and courteously. And you can call any time. GE Answer Center® service is open 24 hours a day, Monday through Saturday.

**OR**

Visit our Website at: [monogram.com](http://monogram.com)

**In Canada, call 1.800.561.3344.**

**In-Home Repair Service**

**In the USA:  
800.444.1845**

**In Canada:  
1.800.561.3344**

A GE consumer service professional will provide expert repair service, scheduled at a time that's convenient for you. Many GE Consumer Service company-operated locations offer you service today or tomorrow, or at your convenience (7:00 a.m. to 10:00 p.m. weekdays, 8:00 a.m. to 6:00 p.m. Saturday and Sunday). Our factory-trained technicians know your appliance inside and out—so most repairs can be handled in just one visit.

In Canada: Monday to Friday, 7:00 a.m. to 8:00 p.m. and Saturday, 8:00 a.m. to 5:00 p.m. EDST.

**For Customers With Special Needs...**

**In the USA:  
800.626.2000**

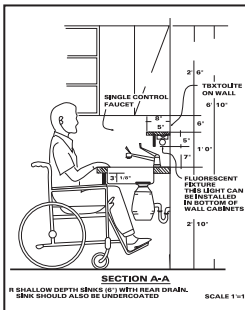

GE offers Braille controls for a variety of GE appliances, and a brochure to assist in planning a barrier-free kitchen for persons with limited mobility.

Consumers with impaired hearing or speech who have access to a TDD or a conventional teletypewriter may call 800.TDD.GEAC (800.833.4322) to request information or service.

**Service Contracts**

**In the USA:  
800.626.2224**

**In Canada:  
1.800.561.3344**

You can have the secure feeling that GE Consumer Service will still be there after your warranty expires. Purchase a GE contract while your warranty is still in effect and you'll receive a substantial discount. With a multiple-year contract, you're assured of future service at today's prices.

**Parts and Accessories**

**In the USA:  
800.626.2002**

**In Canada:  
1.800.561.3344**

**Individuals qualified to service their own appliances** can have parts or accessories sent directly to their home. The GE parts system provides access to over 47,000 parts...and all GE Genuine Renewal Parts are fully warranted. VISA, MasterCard and Discover cards are accepted.

**User maintenance instructions contained in this manual cover procedures intended to be performed by any user. Other servicing generally should be referred to qualified service personnel. Caution must be exercised, since improper servicing may cause unsafe operation.**

**YOUR MONOGRAM REFRIGERATOR WARRANTY**

**Staple sales slip or cancelled check here. Proof of original purchase date is needed to obtain service under warranty.**

**WHAT IS COVERED**

*From the Date of the Original Purchase*

**FULL ONE-YEAR WARRANTY**

For one year from date of original purchase, we will provide, free of charge, parts and service labor in your home to repair or replace any part of the refrigerator that fails because of a manufacturing defect.

**FULL FIVE-YEAR WARRANTY**

For five years from date of original purchase, we will provide, free of charge, parts and service labor in your home to repair or replace any part of the sealed refrigerating system (the compressor, condenser, evaporator and all connecting tubing) that fails because of a manufacturing defect.

**LIMITED LIFETIME WARRANTY ON FULL EXTENSION SLIDES**

From the date of the original purchase we will provide, free of charge, replacement parts for any part of the full extension slides that fails because of a manufacturing defect. You pay for the service trip to your home and for service labor charges.

**LIMITED THIRTY-DAY WARRANTY ON WATER FILTER CARTRIDGE**

From the date of the original purchase we will provide, free of charge, replacement parts for any part of the water filter cartridge that fails because of a manufacturing defect. You pay for the service trip to your home and for service labor charges. During this limited thirty-day warranty, we will also provide, free of charge, a replacement water filter cartridge.

.....  
This warranty is extended to the original purchaser and any succeeding owner for products purchased for ordinary home use in the 48 mainland states, Hawaii, Washington, D.C. or Canada. If the product is located in an area where service by a GE Authorized Servicer is not available, you may be responsible for a trip charge or you may be required to bring the product to an Authorized GE Service location for service. In Alaska the warranty is the same except that it is LIMITED because you must pay to ship the product to the service shop or for the service technician's travel costs to your home.

All warranty service will be provided by our Factory Service Centers or by our authorized Customer Care® servicers during normal working hours.

Should your appliance need service, during warranty period or beyond, in the USA call 800.444.1845. In Canada: 800.561.3344. Please have your serial number and model number available when calling for service.

**WHAT IS NOT COVERED**

- *Service trips to your home to teach you how to use the product.*
- *Improper installation, delivery or maintenance.*  
*If you have an installation problem, contact your dealer or installer. You are responsible for providing adequate electrical, plumbing and other connecting facilities.*
- *Failure of the product if it is used for other than its intended purpose or used commercially.*
- *Damage caused after delivery.*
- *Loss of food due to spoilage (in the USA only).*
- *Damage caused by a non-GE brand water filter."*
- *Replacement of the water filter cartridge due to water pressure that is outside the specified operating range or due to excessive sediment in the water supply.*
- *Replacement of the light bulbs or water filter cartridge other than as noted above.*
- *Replacement of house fuses or resetting of circuit breakers.*
- *Incidental or consequential damage caused by possible defects with this appliance.*
- *Damage to the product caused by accident, fire, floods or acts of God.*
- *Product not accessible to provide required service.*

**EXCLUSION OF IMPLIED WARRANTIES—Your sole and exclusive remedy is product repair as provided in this Limited Warranty. Any implied warranties, including the implied warranties of merchantability or fitness for a particular purpose, are limited to one year or the shortest period allowed by law.**

Some states/provinces do not allow the exclusion or limitation of incidental or consequential damages, so the above limitation or exclusion may not apply to you. This warranty gives you specific legal rights, and you may also have other rights which vary from state to state/province to province. To know what your legal rights are in your state/province, consult your local or state/provincial consumer affairs office or your state's Attorney General.

**Warrantor in USA: General Electric Company,  
Louisville, KY 40225**

**Warrantor in Canada: Mabe Canada Inc.**



**GE Consumer & Industrial**  
Appliances  
General Electric Company  
Louisville, KY 40225  
ge.com

197D3359P008  
49-60649-1