

Monogram.

Use and Care Guide

for ZBD4700
ZBD4800

Dishwasher

1995 Monogram.TM

Dishwasher

CONTENTS

 **Safety Instructions**3

 **Operating Instructions, Tips**
Appliance Registration2
China, Crystal, Sterling10
Cycle Features4
Detergent Guide7
Detergent Dispenser7
Drying Options4
Energy-Saving Tips5
Features4, 5
Loading8, 9
Operating Guide4, 5
Rinse Agent6
Water Temperature5

 **Care and Cleaning**11
Air Gap11
Filters11
Wash Arms11
Winter Storage11

 **Problem Solver**12, 13

 **Consumer Services**14
Model and Serial Numbers2
Warranty15

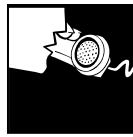

HELP US HELP YOU...

Before using your dishwasher, read this book carefully.

It is intended to help you operate and maintain your new dishwasher properly.

Keep it handy for answers to your questions.

If you don't understand something or need more help, call:

GE Answer Center®

800.626.2000

24 hours a day, 7 days a week

Write down the model and serial numbers.

You'll find them on a label fastened to the tub wall just inside the dishwasher door.

These numbers are also on the Consumer Product Ownership Registration Card that came with your dishwasher. Before sending in this card, please write these numbers here:

_____ Model Number

_____ Serial Number

Use these numbers in any correspondence or service calls concerning your dishwasher.

If you received a damaged dishwasher...

Immediately contact the dealer (or builder) that sold you the dishwasher.

Save time and money. Before you call for service...

Check the Problem Solver. It lists causes of minor operating problems that you can correct yourself.

IF YOU NEED SERVICE

To obtain service, see the Consumer Services page in the back of this book.

We're proud of our service and want you to be pleased. If for some reason you are not happy with the service you receive, here are three steps to follow for further help.

FIRST, contact the people who serviced your appliance. Explain why you are not pleased. In most cases, this will solve the problem.

NEXT, if you are still not pleased, write all the details—including your phone number—to:

Manager, Consumer Relations
GE Appliances
Appliance Park
Louisville, KY 40225

FINALLY, if your problem is still not resolved, write:

Major Appliance
Consumer Action Program
20 North Wacker Drive
Chicago, IL 60606

IMPORTANT SAFETY INSTRUCTIONS



Read all instructions before using this appliance.



WARNING—When using this appliance, always exercise basic safety precautions, including the following:

- Use this appliance only for its intended purpose, as you will find described in this guide.
- Use only powder or liquid detergents or wetting agents recommended for use in a dishwasher. Keep all washing detergents and wetting agents out of reach of children, preferably in a locked cabinet. Observe all warnings on container labels to avoid personal injury.
- When loading items to be washed:
 - A. Locate sharp items so that they are not likely to damage the door seal, and
 - B. Load sharp knives with the handles up to reduce the risk of cut-type injuries.
- Do not wash plastic items unless marked “dishwasher safe” or the equivalent. For plastic items not so marked, check the manufacturer’s recommendations.
- Do not touch the heating element during or immediately after use.
- Do not operate your dishwasher unless all enclosure panels are properly in place.
- Do not tamper with controls.
- Do not abuse, sit on, or stand on the door or dish rack of the dishwasher.
- Close supervision is necessary if this appliance is used by or near children. Do not allow children to play inside, on or with this appliance or any discarded appliance. Dispose of discarded appliances and shipping or packing material properly. Before discarding a dishwasher, remove the door of the washing compartment.



Do not store or use combustible materials, gasoline or other flammable vapors and liquids in the vicinity of this or any other appliance.

- Load light plastic items so they will not become dislodged and drop to the bottom of the dishwasher—they might come into contact with the heating element and be damaged.

To minimize the possibility of electric shock, disconnect this appliance from the power supply before attempting any maintenance. **NOTE:** Turning the dishwasher off does not disconnect the appliance from the power supply. We recommend having a qualified technician service your appliance.

- Do not attempt to repair or replace any part of your dishwasher unless it is specifically recommended in this guide. All other servicing should be referred to a qualified technician.

GROUNDING INSTRUCTIONS



This dishwasher must be properly installed and located in accordance with the Installation Instructions before it is used. If you did not receive an Installation Instructions sheet with your dishwasher, you can obtain one by calling, toll free, the GE Answer Center®, 800.626.2000.

- This appliance must be connected to a grounded metal, permanent wiring system; or an equipment-grounding conductor must be run with the circuit conductors and connected to the equipment-grounding terminal or lead of the appliance.



WARNING—Improper connection of the equipment-grounding conductor can result in a risk of electric shock. Check with a qualified electrician or service representative if you are in doubt whether the appliance is properly grounded.



WARNING—HYDROGEN GAS is produced by the chemical action within your water heater. It can accumulate in the water heater and/or water pipes if hot water has not been used for a period of two weeks or longer. HYDROGEN GAS IS EXPLOSIVE. To prevent the possibility of damage or injury, if you have not used hot water for two weeks or more, or moved into a residence in which the hot water system may not have been used for some time, turn on all hot water faucets and allow them to run for several minutes before using any electrical appliance which is connected to the hot water system. This will allow any hydrogen gas to escape. Also, since the gas is flammable, do not smoke or use an open flame or appliance during this process.

SAVE THESE INSTRUCTIONS



HOW TO OPERATE THE DISHWASHER

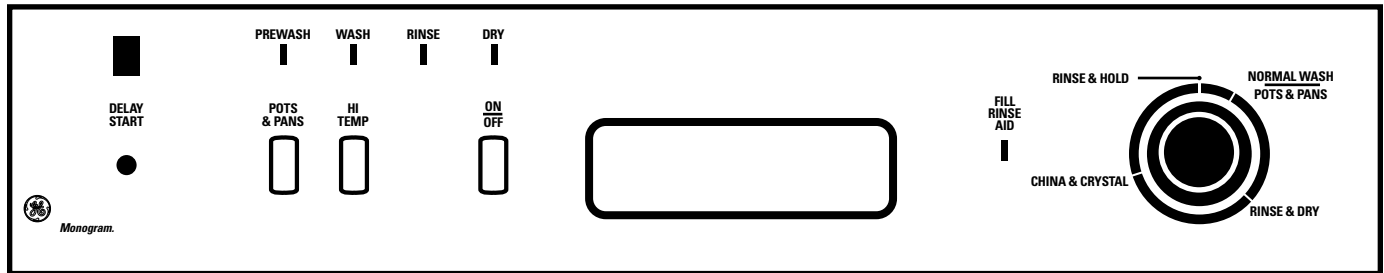

Features and appearance may vary slightly.

STEP 1. Load your dishwasher. See Loading section.

STEP 2. Add detergent to the detergent dispenser. (See Detergent Guide.) For best results use your rinse agent at all times. Not only will it help prevent spotting and provide optimum drying results, but your rinse agent rinses the tub and inner door of your dishwasher which will give it a polished look. See the Rinse Agent section.

STEP 3. The wash arms must be free to move and should not be blocked by an item extending into them.

STEP 4. Latch the door.

STEP 5. Push the Cycle Selector dial so that it is extended. Turn the dial to the cycle you desire by lining up the white line on the dial with the Cycle Indicator on the control panel. Press the corresponding Cycle Selector button if needed or if an option is desired.

- **If You Do Not Wish to Use DELAY START**, continue turning the Cycle Selector dial until the green line on the dial lines up with the cycle indicator on the control panel, then go to Step 6.
- **If You Wish to Use DELAY START**, you can delay the start of a wash cycle for up to 9 hours. Press the ON/OFF button to light up the Delay Start indicator. Tap the Delay Start pad to choose the amount of hours you want to delay the start of the cycle. Turn the Cycle Selector dial until the green line on the dial lines up with the cycle indicator on the control panel.

The machine will start automatically at the correct time. To stop the dishwasher, press the ON/OFF button. Go to Step 7.

- **POTS & PANS**—For items such as pots, pans and casseroles with dried-on or baked-on soils. Everyday dishes may be included. Burned-on food and food burned black should be presoaked and scoured. The dishwasher cannot remove burned-on food. Press POTS & PANS button; then select POTS & PANS on Cycle Selector dial; press ON button. You may also select HI TEMP to get extra cleaning in this cycle.
- **NORMAL WASH**—For loads of everyday dishes, glasses and cookware with medium soils. Designed to yield high performance on normal soils. You can also select HI TEMP to get extra cleaning in this cycle.
- **RINSE & DRY**—Rinses and dries dusty dishes that are already washed. *Do not use detergent.*
- **CHINA & CRYSTAL**—For lightly soiled china and crystal.
- **RINSE & HOLD**—For rinsing partial loads which will be washed later. *Do not use detergent.*

STEP 6. To **start** the dishwasher, press the ON/OFF button. To **stop** the dishwasher press the ON/OFF button.

STEP 7. The dishwasher cycle is complete when the DRY light goes out. Clean the filter.

Cycle Phase Lights

These lights tell you what stage the machine is in.

Fill Rinse Aid Light

Indicates rinse aid agent needs to be added to the machine.

Drying

The dishwasher has an energy efficient wash and dry system. The heat energy from the wash cycle is used to dry the dishes. After the wash cycle it will take an additional 45 minutes for a typical load of dishes to dry. Quicker drying can be accomplished by opening the door slightly. The use of a rinse agent is recommended. It will improve drying and lessen water spotting.

To Interrupt a Cycle

To interrupt a cycle, press the ON/OFF button. If you're interrupting the cycle during a wash or rinse cycle wait until the water noises stop before opening the door. The cycle may be resumed by closing the door and pressing the ON/OFF button again. **As a safety feature the dishwasher will automatically turn itself off whenever the door is opened.** However, if the door is opened quickly while in a wash or rinse cycle some water may splash out of the dishwasher. For this reason it is recommended that the machine always be switched to off before opening the door. **If you have used the ON/OFF button to interrupt the cycle, remember to turn the machine back on by pressing ON/OFF.**

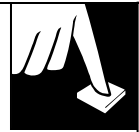

What Happens in Each Cycle

Cycles	Water Use Gallons (approx.)	Wash Cycle Time Minutes (approx.)	Cycle Sequence					
POTS & PANS	7.3	90–95	Pre Wash	Wash	Rinse	Rinse	Rinse	Dry
NORMAL WASH	5.7	80–87	Pre Wash	Wash	Rinse	Rinse		Dry
RINSE & DRY	4	50			Rinse	Rinse		Dry
CHINA & CRYSTAL	4.4	53		Wash	Rinse	Rinse		Dry
RINSE & HOLD	1.8	8				Rinse		

Energy-Saving Tips

- **Operate dishwasher only when it's full.** Let the dishes accumulate in dishwasher. When you put in only a partial load, use the RINSE & HOLD cycle to rinse off heavy soils. Be sure to latch the door when waiting for a full load. This helps keep soils moist, easier to remove.
- If you don't need your dishes right away, open your dishwasher door and they will dry naturally over a longer period such as overnight.
- **Always select the cycle that uses the least amount of water that will remove the soil from the load.**

Good Dishwashing Starts with HOT Water

To get dishes clean and dry, you need hot water. To help you get water of the proper temperature, your dishwasher automatically heats the water in the wash cycle. For good washing and drying, the entering water must be at least 120°F. To prevent dish damage, inlet water should not exceed 150°F.

How to Test Water Temperature

Higher water temperature is needed to dissolve grease and activate powder detergents.

Check your water temperature with a candy or meat thermometer. Turn on the hot water faucet nearest the dishwasher. Put the thermometer in a glass and let the water run continuously into the glass until the temperature stops rising. If the water temperature is below 120°F, adjust your water heater.

Helpful Hints

If outside temperatures are unusually low, or if your water travels a long distance from water heater to dishwasher, you may need to set your water heater's thermostat up. If you have not used hot water for some time, the water in the pipes will be cold. Turn on the hot water faucet at the sink and allow it to run until the water is hot. Then start the dishwasher.

If you've recently done laundry or run hot water for showers, give your water heater time to recover before operating the dishwasher.

To improve washability if the water is less than 120°F and you cannot adjust your water heater: Select a longer cycle and fill both detergent cups at least half full with detergent.



How to Use a Rinse Agent

It is recommended that a liquid rinse agent be used at all times with your dishwasher. Do not use powder or solid rinse agents.

Your rinse agent has a dual purpose with your dishwasher. It makes water flow off dishes quicker than usual. This lessens water spotting and makes drying faster, too. The rinse agent also serves to rinse the tub and the inner door of the dishwasher. Your tub and inner door will begin to take on a dull, unpolished look if rinse agent is not used.

For best dishwashing performance, use of a rinse agent such as JET-DRY brand is recommended.

Your dishwasher is equipped with a reservoir for storing and dispensing liquid rinse agent.

To fill the rinse agent reservoir:

- Remove the reservoir cap.
- Pour the rinse agent into the reservoir until the clear level indicator turns completely dark. The reservoir is full when the level indicator is dark.
- Replace rinse agent reservoir cap. A full reservoir will provide enough rinse agent for approximately 30 washes.

Rinse Agent Indicator

On your control panel is the rinse agent indicator. This indicator light shows you the level of the rinse agent that is in the rinse agent reservoir. When the indicator light is illuminated the rinse agent reservoir is empty and when this indicator light appears dark the rinse agent reservoir is full.



Rinse Agent Dispenser Regulator

Your rinse agent reservoir is provided with a regulator. This regulator controls the amount of rinse agent dispensed.

- If water spots appear, it is recommended that the regulator be turned to a higher number.
- If you see streaks, it is recommended that the regulator be turned to a lower number.

To adjust the dispenser regulator:

- Open the rinse agent reservoir.
- Adjust to a higher or lower number as needed.
- Securely close the rinse agent reservoir.

If you accidentally spill: Wipe up the rinse agent with a damp cloth. Don't leave the spill in the dishwasher. It can keep your detergent from working.

If you can't find any rinse agent, write:

BENCKISER CONSUMER PRODUCTS, INC.
("JET-DRY")
Corporate Centre 1
55 Federal Road
P.O. Box 1991
Danbury, CT 06813-1991

How to Choose and Use the Right Detergent

Use only powder or liquid detergent specifically made for use in dishwashers. Other types will cause oversudsing.

How much detergent should you use? That depends. Is your water "hard" or "soft"? With hard water, you need extra detergent to get dishes clean. With soft water, you need less detergent.

Your water department can tell you how hard your water is. So can your county extension agent or your area's water softener company. Just call and ask them how many "grains" of hardness there are in your water.

Too much detergent with soft water not only wastes money, it can be harmful. It can cause a permanent cloudiness of glassware called "etching." An outside layer of glass is etched away! Of course, this takes some time. But why take a chance when it's easy to find out the hardness of your water.

Keep your detergent fresh and dry. Under the sink isn't a good place to store detergent because there is too much moisture. Don't put powder detergent into the dispenser until you're ready to wash dishes, either. (It won't be fresh OR dry.)

If your powder detergent gets old or lumpy, throw it away. Old detergent often won't dissolve. If you use a liquid dishwasher detergent, these precautions are not necessary because liquid detergents don't "lump" as they age or come in contact with moisture.

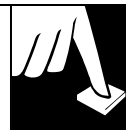

Detergent Dispenser

To open your detergent dispenser cover, press the retainer button. The cover will flip back.

Once the cover is open, fill the detergent main cup compartment with detergent, as suggested in the guide below. Close the cover until it clicks shut.

Some cycles will also require the open cup to be filled. See the guide below for the suggested amount of detergent to use.

The detergent will be dispensed automatically during the wash portion of the cycle.

If you have a problem closing the cover of the detergent dispenser, it is likely due to excess detergent in the area where the cover seals. Brush the detergent away from the seal area and relatch. If the cover still will not close it may be because the machine was stopped in the wash portion of the cycle.

Detergent Usage Guide (powder or liquid)

CYCLES	SOFT WATER 0-3 grains		MEDIUM WATER 3-7 grains		HARD WATER 7-12 grains*	
	Main Cup	Open Cup	Main Cup	Open Cup	Main Cup	Open Cup
POTS & PANS	Full	None	Full	Full	Full	Full
NORMAL WASH	$\frac{1}{2}$ Full	None	Full	None	Full	Full
CHINA & CRYSTAL	$\frac{1}{2}$ Full	None	$\frac{1}{2}$ Full	None	Full	Full
RINSE & DRY	Use no detergent		Use no detergent		Use no detergent	
RINSE & HOLD	Use no detergent		Use no detergent		Use no detergent	

*12 grains and up is extremely hard water. A water softener is recommended. Without it, lime can build up in the water valve. The water valve may stick and flooding could occur.

NOTE: The above chart is a general guide. Detergent amounts should be adjusted depending on the amount and type of soil until satisfactory results are achieved.

How to Prepare the Dishes for Washing

If this is your first dishwasher, or if you're replacing a much older model, you may wonder how much preparation your dishes need. Actually very little. Scrape off bones, seeds, skins, toothpicks and other hard solids. Remove excessive quantities of oil or grease.

NOTE: You may also want to consider removing foods such as mustard, mayonnaise, vinegar, lemon juice and other foods that can cause discoloration of stainless steel if allowed to remain on dishes for a long period of time.

The POTS & PANS cycle can wash heavily soiled dishes and remove dried-on and baked-on soils from pots, pans and casseroles. Items with burned-on soils need extra preparation.



HOW TO LOAD YOUR DISHWASHER

Your dishwasher should be loaded so that water can circulate freely and reach every part of every item that is to be cleaned. When unloading the dishwasher always unload the bottom rack first and then unload the upper rack. This sequence of unloading will minimize the chance of water drops from the upper rack falling on the dishes in the bottom rack. The silverware basket of the dishwasher has a handle to allow easy removal of the basket to your silverware drawer for unloading.

How to Load the Upper Rack

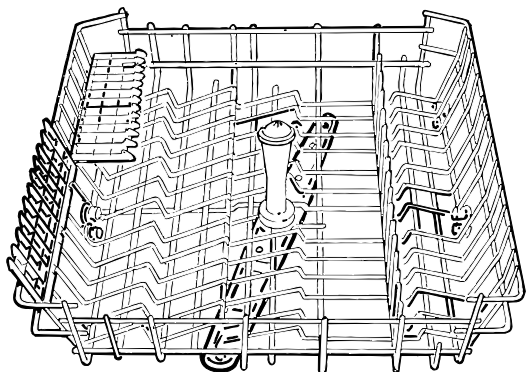

- The upper rack is best for glasses, cups and saucers. Two rows of cups can be washed when using the folding shelf. Load the bottom row first, then fold down the shelf and load the top row. Cups and glasses fit best along the sides. This is the place for dishwasher-safe plastics, too. Make sure small plastic items are lodged in tightly so they can't fall onto the heating element. Arrange stemware so that it cannot move easily. Don't let the glasses touch each other.
- Saucepans, mixing bowls and other small items may be placed—face down—in this upper rack. The upper rack is handy for all kinds of odd shapes.

Upper Rack Height Adjustment

The upper rack has two adjustable positions. The upper rack may be placed in the upper position to provide more room for large items like platters to be placed in the bottom rack—or—the upper rack may be placed in the lower position to provide additional room for items such as tall glasses to be placed in the upper rack.

To reposition the upper rack:

1. Empty upper rack and pull it partially out to allow access to the latches at the front of the roller channels.
2. Release the latches on both channels, left and right, by flipping them towards the outside of the dishwasher.
3. Pull the upper rack forward until rollers are completely free of the channels.
4. Push channels back into dishwasher until they stop.
5. Reinsert upper rack.
6. With rollers within channels, close latches by flipping them closer toward the center of the dishwasher.

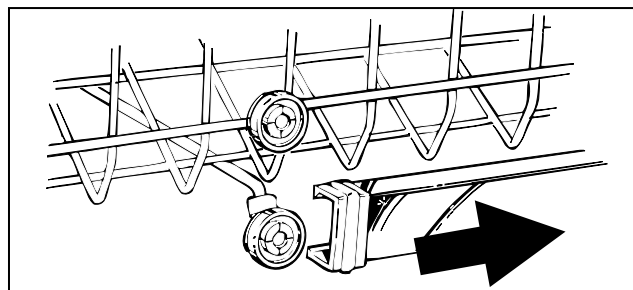
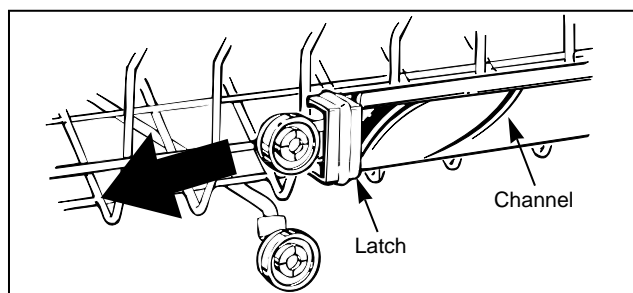



How to Load the Bottom Rack

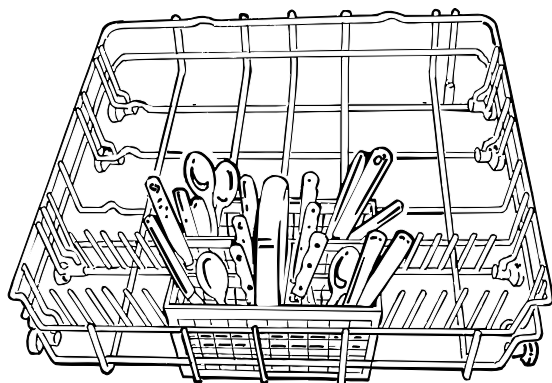

- Fit plates and saucers between the pins. Load platters, pots and bowls along the sides, in corners or in the back.
- Heavily soiled pots, pans and casseroles **MUST** be loaded in the bottom rack, facing down. Prop broiler pans and racks along the edge. Shallow items may be angled provided the lower side does not shield the soiled surface inside from the water.
- Put flatware in the removable basket with fork and knife handles up to protect your hands. Place spoons in the basket with handles down. Mix knives, forks and spoons so they don't nest together. Distribute evenly.

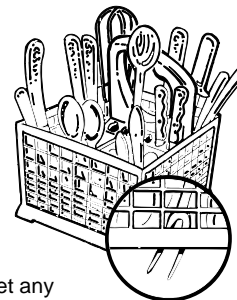

Don't let any item extend through bottom

Upper Rack

Customizing Your Bottom Rack

The bottom rack is designed so you may easily rearrange its parts for different heights, angles and sizes of your dishware. **NOTE: You can only use two removable racks in the bottom rack at one time.**

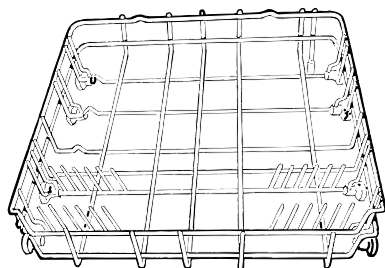

BOTTOM RACK

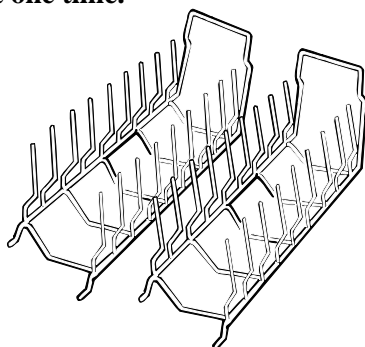

2 REMOVABLE RACKS WITH PINS FOR EASY PLACING OF POTS, PANS, PLATES, ETC.

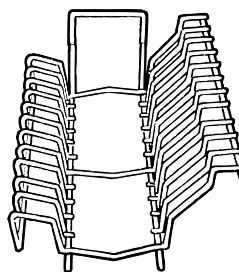

REMOVABLE CHINA RACK FOR EASY PLACING OF CHINA. PLACE IN RIGHT HAND SIDE OF BOTTOM RACK ONLY.

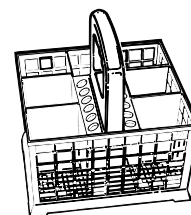

SILVERWARE BASKET

Bottom Rack



WHAT YOU CAN USUALLY WASH SAFELY IN YOUR DISHWASHER

Material	Usually Safe	Exceptions (not safe)	Special Instructions
Aluminum	YES	Some colored anodized aluminum can fade.	Some darkening or spotting possible. Remove by scouring with soap-filled steel wool pads.
China/ Stoneware	YES	Antique, metal-trimmed, hand-painted or over-the-glaze patterns fade. Gold leaf will discolor.	If in doubt, check with the manufacturer. Or test wash one piece daily for at least a month. Compare with the rest of the set.
Crystal	YES	Antique, metal-trimmed or hand-painted patterns fade. Gold leaf will discolor.	Load securely to prevent movement. Select CHINA & CRYSTAL cycle. Check your manufacturer's instructions for your crystal.
Non-dishwasher items—such as electronic air cleaner filters, furnace filters, paint brushes, etc.	NO		Do not wash in dishwasher. Damage to dishwasher and discoloration or staining of dishwasher may result.
Glass	YES	Milk glass may yellow.	
Iron	NO	Iron will rust.	
Pewter	NO	Pewter tarnishes.	
Plastics	YES		If it doesn't say DISHWASHER SAFE, test one piece in the top rack before dishwashing an entire set.
Stainless steel	YES		Rinse if not washing immediately. Salty or acidic foods can stain if left on.
Sterling silver and silver plate	YES	Don't put in same silverware basket with stainless steel. Contact between metals can damage silver. Don't wash copper utensils in the same load. Silver may get a brown film. Adhesive used to attach some hollow-handle knives can loosen.	Rinse if not washing immediately. Salty or acidic foods can stain if left on. Dry detergent can cause difficult-to-remove black spots. Place in back section of silverware basket to avoid exposure to detergent from the detergent cup.
Non-stick coatings	YES		After washing, wipe the non-stick coating area with vegetable oil to keep it from losing its non-stick quality.
Tin	NO	Tin can rust.	
Wood	NO	Wood can warp, crack or lose its finish with any type of washing.	

Forget a Dish? Here's When You Can Add It

Add dishes any time during the wash cycle.
See the Operating section, for easy instructions.

CARE AND CLEANING

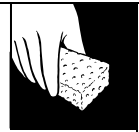

Clean the outer surface and door jambs with a **lightly dampened cloth**. Dry thoroughly. Do not use abrasives or sharp objects, they can damage the dishwasher.

The inside usually takes care of itself. Keeping your rinse agent dispenser filled all the time will give the tub and inner door of your dishwasher a polished appearance.

Not Using Your Dishwasher in Winter? Protect Against Freezing

If your dishwasher is left in an unheated place during the winter, ask a service technician to:

- Cut off electric power to the dishwasher. Remove fuses or trip circuit breaker.
- Turn off the water supply.
- Disconnect the water inlet line from the water valve.
- Drain water from the inlet line and water valve. (Use a pan to catch the water.)
- Reconnect the water inlet line to the water valve.
- Pour 1 cup non-toxic antifreeze into the sump. (Non-toxic antifreeze available at recreational vehicle stores.)

Built-in Dishwashers Often Use an Air Gap. Keep It Clean

An air gap is a plumbing device. It protects your dishwasher against water backing up into it if a drain clogs. The air gap is not a part of the dishwasher. And you may not even have one. Not all plumbing codes require air gaps.

Check the air gap any time your dishwasher isn't draining well.

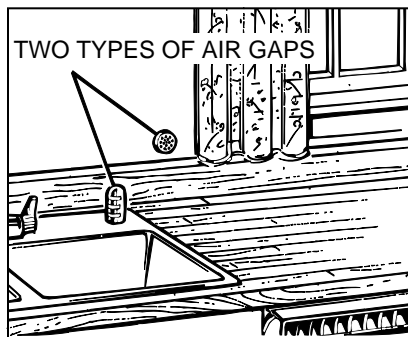

If you have an air gap, check it at least once a month. **IT IS NOT PART OF YOUR DISHWASHER. IT IS NOT COVERED IN YOUR WARRANTY.**

The air gap is easy to clean.

With most types, first turn off the dishwasher, then lift off the chrome cover. Then unscrew the plastic cap and check for any buildup of grit. A toothpick makes cleaning easy.

Keeping Your Dishwasher Filters Clean

Your dishwasher has a filter system comprised of a central filter and a microfilter. At the end of each wash, remove the filter from the bottom of the dishwasher and make sure it is clean.

To check to see if the filter is clogged or dirty, first remove the lower wash arm by lifting it up and off. Turn the center filter assembly handle counterclockwise and pull out.

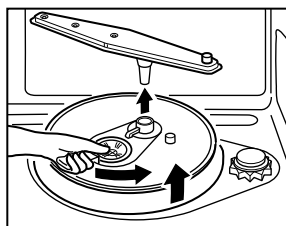

Remove the microfilter by pulling it down away from the center filter assembly. Then press the tabs on the inner filter and remove it also. Clean all filter parts with water and a stiff bristled brush.

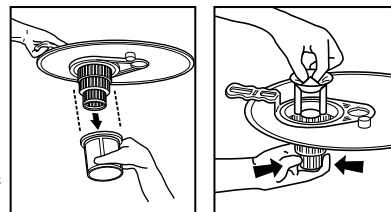

To replace, line up the dome on the tube, press down and lock into place by turning clockwise. Replace the wash arm.

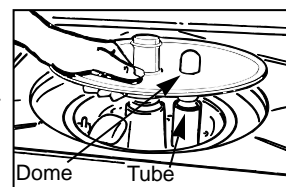

Keeping Your Dishwasher Wash Arms Clean

The wash arms should be checked on a regular basis to assure that the spray orifices are clear and unobstructed. If wash arms require cleaning they are easily removable.

The lower wash arm can be removed by pulling upwards. The upper wash arm is held in position by a knurled nut. Clean with water and a stiff bristled brush and replace.



QUESTIONS? USE THIS PROBLEM SOLVER

PROBLEM	POSSIBLE CAUSE
CYCLE PHASE LIGHTS DON'T COME ON	A fuse in your home may be blown, or the circuit breaker tripped. Replace fuse or reset circuit breaker.
DISHWASHER DOESN'T START	<ul style="list-style-type: none">• Dishwasher door may not be closed securely. Close door until you hear it click.• Turn dishwasher on.• Cycle not selected. Turn to desired cycle.
DISHES NOT CLEAN	<ul style="list-style-type: none">• Spray arms blocked. Check for free rotation of both upper and lower arms.• Water inlet temperature too low. Maintain at least 120°F inlet temperature.• Not enough detergent used. Check usage recommendation in Detergent Guide.• Drain blocked or filter clogged. Check filters in bottom of machine and at water inlet and clear as required. Check drain air gap on sink or wall and check drain outlet. Clean or repair as required.• Clogged nozzles in wash arm. Clean as described in Care and Cleaning section.• Wrong cycle selected. Try longer cycle.
WATER NOT PUMPED FROM DISHWASHER	Kink in drain hose. Filters clogged. Drain pipe clogged. See Care and Cleaning section. If problem is in sink or drain, you may need a plumber.
UNUSUAL NOISES	Dishes or utensils being struck by water or spray arm. Rearrange dishes.
DISHES DON'T DRY	<ul style="list-style-type: none">• Make sure inlet water temperature is correct. See How to Test Water Temperature section.• Unload the bottom rack first. Water from dishes in the upper rack may be spilling into the bottom rack.• Check for improper loading. Dishes shouldn't nest together. Avoid overloading.• Check the rinse aid agent dispenser to see that it's not empty.• The use of a rinse agent will improve drying performance.• Dishes will dry faster if you open the door slightly.



PROBLEM	POSSIBLE CAUSE
SPOTS AND FILMING ON GLASSES AND FLATWARE	<p>Spotting can be caused by all these things:</p> <ul style="list-style-type: none">• Extremely hard water. (See How to Choose and Use Detergent section.)• Low inlet water temperature. (See How to Test Water Temperature section.)• Overloading the dishwasher.• Improper loading. (See Loading section.)• Old or damp powder detergent.• Phosphate level in detergent too low. (See How to Choose and Use Detergent section.)• Rinse agent dispenser empty. (See How to Use Rinse Agent section.)• Too little detergent. (See How to Choose and Use Detergent section.) <p>Local water conditions and personal preferences vary. Try several brands of detergent to find one that gives the best results for you. A liquid dishwasher detergent may help reduce filming.</p>
YELLOW OR BROWN FILM	<p>Tea or coffee can stain cups. Remove the stain by hand, using a solution of 1/2 cup bleach and 3 cups warm water.</p> <p>An overall yellow or brown film on dishes or glassware can be caused by iron deposits in water. A special filter in the water supply line is the only way to correct this problem. Your water softener company can tell you about the filter.</p> <p>Yellow film on sterling silver results when you wash copper utensils in the same load. Silver polish will usually remove this stain.</p>
SPRAY ARMS DO NOT ROTATE FREELY	Remove spray arms and clean.

If you need more help...call, toll free:
GE Answer Center®
800.626.2000
consumer information service

We'll Be There

With the purchase of your new Monogram appliance, receive the assurance that if you ever need information or assistance from GE, we'll be there. All you have to do is call—toll-free!

GE Answer Center[®] **800.626.2000**

Whatever your question about any Monogram major appliance, GE Answer Center[®] information service is available to help. Your call—and your question—will be answered promptly and courteously. And you can call any time. GE Answer Center[®] service is open 24 hours a day, 7 days a week.

In-Home Repair Service **800-GE-CARES (800-432-2737)**

A GE consumer service professional will provide expert repair service, scheduled at a time that's convenient for you. Many GE Consumer Service company-operated locations offer you service today or tomorrow, or at your convenience (7:00 a.m. to 7:00 p.m. weekdays, 9:00 a.m. to 2:00 p.m. Saturdays). Our factory-trained technicians know your appliance inside and out—so most repairs can be handled in just one visit.

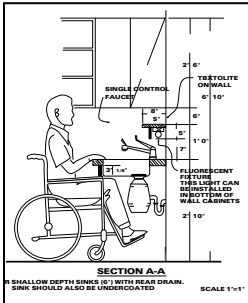

For Customers With Special Needs... **800.626.2000**

Upon request, GE will provide Braille controls for a variety of Monogram appliances, and a brochure to assist in planning a barrier-free kitchen for persons with limited mobility. To obtain these items, free of charge, call 800.626.2000.

Consumers with impaired hearing or speech who have access to a TDD or a conventional teletypewriter may call 800-TDD-GEAC (800-833-4322) to request information or service.

Service Contracts **800-626-2224**

You can have the secure feeling that GE Consumer Service will still be there after your warranty expires. Purchase a GE contract while your warranty is still in effect and you'll receive a substantial discount. With a multiple-year contract, you're assured of future service at today's prices.

Parts and Accessories **800-626-2002**

Individuals qualified to service their own appliances can have parts or accessories sent directly to their home. The GE parts system provides access to over 47,000 parts...and all GE Genuine Renewal Parts are fully warranted. VISA, MasterCard and Discover cards are accepted.

User maintenance instructions contained in this booklet cover procedures intended to be performed by any user. Other servicing generally should be referred to qualified service personnel. Caution must be exercised, since improper servicing may cause unsafe operation.

YOUR MONOGRAM DISHWASHER WARRANTY

Staple sales slip or cancelled check here. Proof of original purchase date is needed to obtain service under warranty.

WHAT IS COVERED

FULL ONE-YEAR WARRANTY

For one year from date of original purchase, we will provide, free of charge, parts and service labor in your home to repair or replace **any part of the dishwasher** that fails because of a manufacturing defect.

LIMITED SECOND-YEAR PARTS WARRANTY

For the second year from date of original purchase, we will provide, free of charge, replacement parts for **any part of the dishwasher** that fails because of a manufacturing defect. You pay for the service trip to your home and service labor charges.

LIMITED FIVE-YEAR RACK WARRANTY

For five years from date of original purchase, we will provide, free of charge, replacement parts for any **rack** that rusts because of a manufacturing defect

You pay for the service trip to your home and service labor charges.

FULL TWENTY-YEAR TUB/DOOR LINER WARRANTY

For twenty years from date of original purchase, we will provide, free of charge, parts and service labor in your home to repair or replace **the stainless steel tub or door liner** if it fails to contain water because of a manufacturing defect.

This warranty is extended to the original purchaser and any succeeding owner for products purchased for ordinary home use in the 48 mainland states, Hawaii and Washington, D.C. In Alaska the warranty is the same except that it is LIMITED because you must pay to ship the product to the service shop or for the service technician's travel costs to your home.

All warranty service will be provided by our Factory Service Centers or by our authorized Customer Care[®] servicers during normal working hours.

Should your appliance need service, during warranty period or beyond, call 800-GE-CARES (800-432-2737).

WHAT IS NOT COVERED

- Service trips to your home to teach you how to use the product.
- **Read your Use and Care material.** If you then have any questions about operating the product, please contact your dealer or our Consumer Affairs office at the address below, or call, toll free: GE Answer Center[®] 800.626.2000 consumer information service
- Improper installation.

If you have an installation problem, contact your dealer or installer. You are responsible for providing

adequate electrical, plumbing, and other connecting facilities.

- Replacement of house fuses or resetting of circuit breakers.
- Cleaning or servicing of air gap device in drain line.
- Failure of the product if it is used for other than its intended purpose or used commercially.
- Damage to product caused by accident, fire, floods or acts of God.

WARRANTOR IS NOT RESPONSIBLE FOR CONSEQUENTIAL DAMAGES.

Some states do not allow the exclusion or limitation of incidental or consequential damages, so the above limitation or exclusion may not apply to you. This warranty gives you specific legal rights, and you may also have other rights which vary from state to state. To know what your legal rights are in your state, consult your local or state consumer affairs office or your state's Attorney General.

Warrantor: General Electric Company

**If further help is needed concerning this warranty, write:
Manager—Consumer Affairs, GE Appliances, Louisville, KY 40225**



Monogram™

General Electric Company
Louisville, KY 40225

I95900116.00
Pub. No. 49-5714
Part No. 165D4700P058
12-95 CG
Printed in Italy