

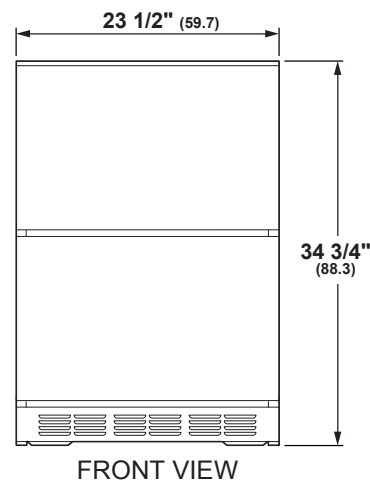

OVERALL DIMENSIONS

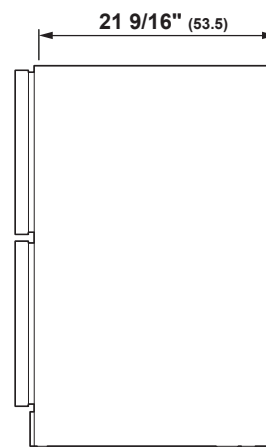

FRONT VIEW



SIDE VIEW

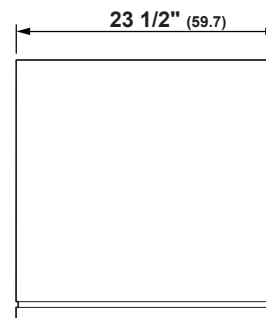

TOP VIEW

Dimensions in parentheses are in centimeters unless otherwise noted.

Actual product dimension may vary due to manufacturing tolerances.

SPECIFICATIONS

Overall Width	23 1/2" (59.7 cm)
Overall Height	34 3/4" (88.3 cm)
Overall Depth	23 1/4" (59.1 cm)
Overall Capacity	5.0 cu. ft.
Minimum Cabinet Width	23 3/4" (60.3 cm)
Minimum Cabinet Depth	24" (61.0 cm)
Cutout Width	23 3/4" (60.3 cm)
Cutout Height	34 1/2" (87.6 cm) Min 35" (88.9 cm) Max
Electrical Requirements	1.2 A
Voltz/Hertz/Amps	120 V, 60 Hz, 15 or 20 amp circuit
Shipping Weight	126 lb (57 kg)

ATTENTION ELECTRICIAN:

A 115 volt 60Hz., 15 or 20 amp power supply is required. An individual properly grounded branch circuit or circuit breaker is recommended. Install a properly grounded 3-prong electrical receptacle recessed into the back wall.

ELEVATE EVERYTHING™



INSTALLATION

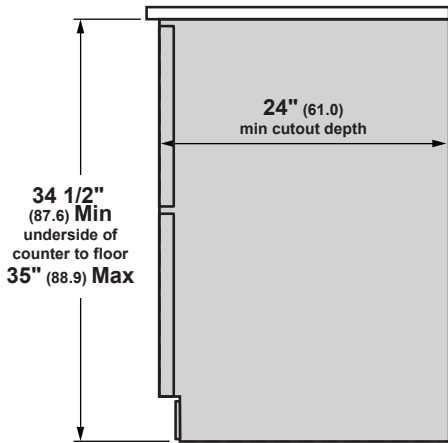

FLUSH CUTOUT INSTALLATION
SIDE VIEW

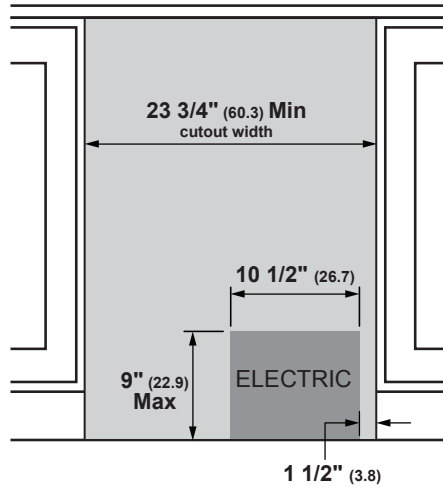

INSTALLATION CUTOUT
FRONT VIEW

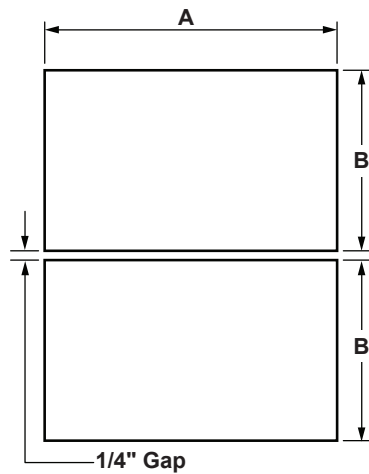

CUSTOM PANELS

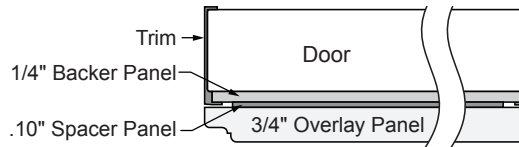

3/4" OVERLAY PANEL DIMENSIONS
(IN INCHES)

	A (WIDTH)	B (HEIGHT)
1/4" Backer	23 3/16"	14 11/16"
.10" Spacer	22 1/2"	14 3/16"
3/4" Overlay	23 5/8"	15 1/16"

Note: Max assembled drawer panel wight is 25 lbs.
IMPORTANT: Maintain a 1/4" gap between the panels when installed.

NOTES

Model can be installed flush with standard cabinetry.
Designed to be built-in only. Cannot be used free-standing.
Black vented toekick with optional stainless steel toekick supplied.

FEATURES AND BENEFITS

DIGITAL TOUCH CONTROLS

Offer a range of temperatures for precise chilling of a variety of fresh foods and beverages, and a LED display allows easy viewing of temperatures

FULL-EXTENSION SLIDE-OUT REFRIGERATED DRAWERS

Storage for everything from whole melons to 146 12-oz. cans

SPACIOUS INTERIOR WITH ADJUSTABLE DIVIDERS, FOLD-DOWN SHELF AND REMOVABLE DRAWER BIN

Maximizes useable storage space and flexibility

SOFT INTERIOR LED LIGHTING

Automatically illuminates when the door is open, but can be activated by an internal on/off switch

FLUSH INSTALLATION

Allows near-seamless integration with surrounding cabinetry

CUSTOM-PANEL READY

Lets you coordinate models within cabinetry for a look of elegant understatement. Customer must choose a custom door panel and handle to complement their decor



ELEVATE EVERYTHING™

MONOGRAM