

MONOGRAM 30" BUILT-IN ADVANTIUM® 240 ZSB9231NSS

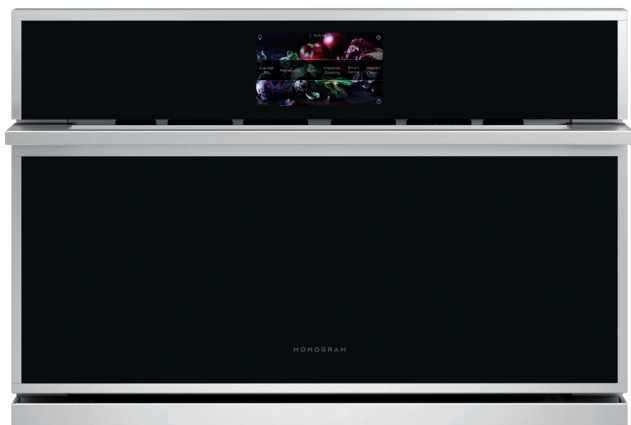

THE MONOGRAM MINIMALIST COLLECTION

Streamlined design and precisely machined metals create a contemporary yet functional aesthetic

PRECISION COOKING MODES

Master new recipes and perfectly execute favorite dishes using this ultra-smart system that automatically tracks cooking progress, modifies temperatures and adjusts cook times

5-IN-1-OVEN

Experience exceptional flexibility and cooking results with this innovative five-in-one oven. Advantium® Technology enhanced, it can be used as a convection oven, toaster oven, warming/proofing oven, precision cook oven, and microwave

POWERFUL PERFORMANCE

Oven-quality foods cook up to eight times faster than a conventional oven, with no preheating required

SOPHISTICATED STYLING

Elegant design and clean lines offer a stylish, modern look that complements the rest of the Monogram kitchen

SPACIOUS INTERIOR

Generous, 1.7-cu.-ft oven space with a large 16" turntable allows for full rotation of a 9" x 13" casserole dish; plus the removable oven rack offers the convenience of multi-level cooking

PREPROGRAMMED RECIPES

Provide quick and easy programming of over 175 pre-set food selections and allows programming of up to 30 custom recipes

INSTALLATION FLEXIBILITY

Ovens can be installed in 30" wall cabinet

LCD CONTROLS

Allow you to adjust oven settings with little effort

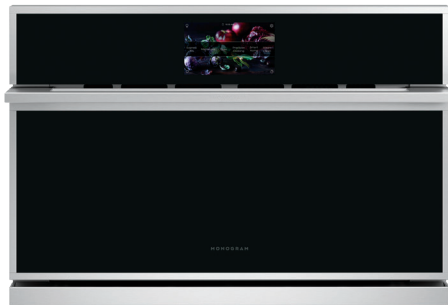

SPECIFICATIONS

Overall Width	29 3/4" (75.6)
Overall Height	20 1/4" (51.4)
Overall Depth (includes control panel thickness)	22 7/8" (58.1)
Oven Door Clearance	13 1/4" (33.7)
Overall Oven Interior Capacity	1.7 cu. ft.
Oven Interior Dimensions (W x H x D)	20 1/16" x 8 1/2" x 17" (51 cm x 21.6 cm x 43.2 cm)
Minimum Cabinet Width	30" (76.2)
Minimum Cabinet Depth	23 1/2" (59.7)
Minimum Base Support	130 lbs (59 kg)
Cutout Width	25 1/4" (64.1)
Cutout Height	17 1/2" (44.5)
Cutout Depth	23 1/2" (59.7)
Voltz/Hertz/Amps	240/208 VAC, 60 Hz, 30A
Conduit Length	48 1/2" (123.2)
Electrical Rating	4.72 kW at 208V 6.3 kW at 240V
Total Amps	30" (76.2)
Shipping Weight	87 lbs (39.5 kg)

ATTENTION ELECTRICIAN:

A 240/208V, 60Hz, 30 Amp circuit is required. An individual properly grounded branch circuit or circuit breaker is required. Hardware junction box is required for built-in product.

OVERALL DIMENSIONS

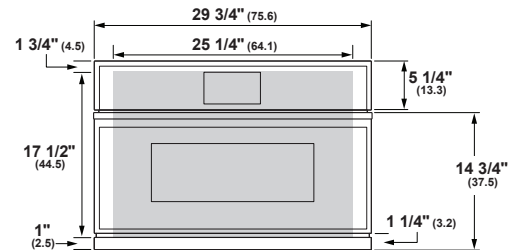

FRONT VIEW (SHOWING CUTOUT OVERLAP)

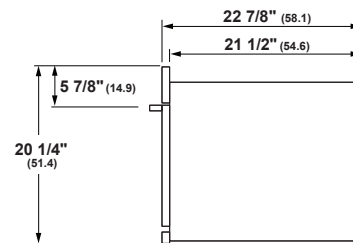

SIDE VIEW

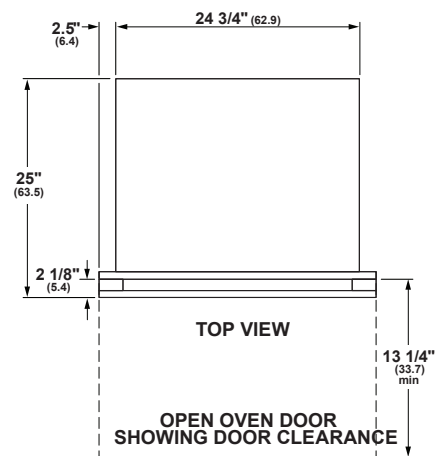

TOP VIEW

OPEN OVEN DOOR
SHOWING DOOR CLEARANCE

Dimensions in parentheses are in centimeters unless otherwise noted. Actual product dimensions may vary due to manufacturing tolerances.

WALL INSTALLATION

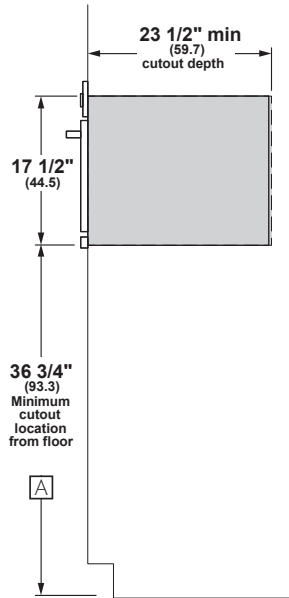

**STANDARD
INSTALLATION**

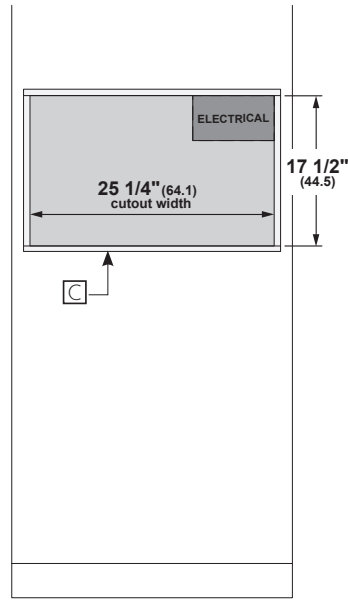

**STANDARD INSTALLATION
FRONT VIEW**

HELPFUL TIPS

- A Based on a user height of 5' 6" to 5' 10"
- B Junction box location (May also be located in adjacent cabinet.)
- C Platform must be able to support cabinet load, weight of oven, and additional oven loads

For more details, refer to the installation instructions for this product on Monogram.com. Dimensions in parentheses are in centimeters unless otherwise noted.